

# Bosch Rexroth EFC5610 Frequency Inverter

# Easy Start Guide



The Bosch Rexroth EFC5610 Frequency Inverter range is available to order from [inverterdrive.com](http://inverterdrive.com)

This guide is intended to complement the user manual provided by the manufacturer. It is provided as a basic introduction to the product for Inverter Drive Supermarket customers. It should not be used as a replacement for the manual issued by the manufacturer.



**This product is not a safety device. All safety considerations including but not limited to Emergency Stop provision should be assessed separately and are outside the scope of this guide.**

## Contents

Page 1	Contents
Page 2	Power and Motor Connections (Single Phase)
Page 3	Power and Motor Connections (Three Phase)
Page 4	Motor Connections - Star and Delta
Page 5	Parameters - Overview Parameters to set before use
Page 6	How to set a Parameter value
Page 7	How to Operate the Inverter from the keypad
Page 8	How to enable Sensorless Vector control
Page 9	How to connect and configure a Potentiometer for remote speed control
Page 10	How to connect and configure a Run Forward or Run Reverse switch
Page 11	How to connect and configure a Run/Stop switch with Forward/Reverse selection
Page 12	How to configure “3-Wire” control with Run/Stop pushbuttons and Forward/Reverse selection
Page 13	Brake Resistor Connection
Page 14	STO (Safe Torque Off) Connections
Page 15	How to Reset the Inverter to Factory Defaults

# Easy Start Guide

Bosch Rexroth EFC 5610 Series Inverter

## 1. Power and Motor Connections (Single Phase)



Before commencing, confirm that the Inverter and all cables are completely isolated from the power supply, have been isolated for at least 5 minutes and that the motor is not turning.

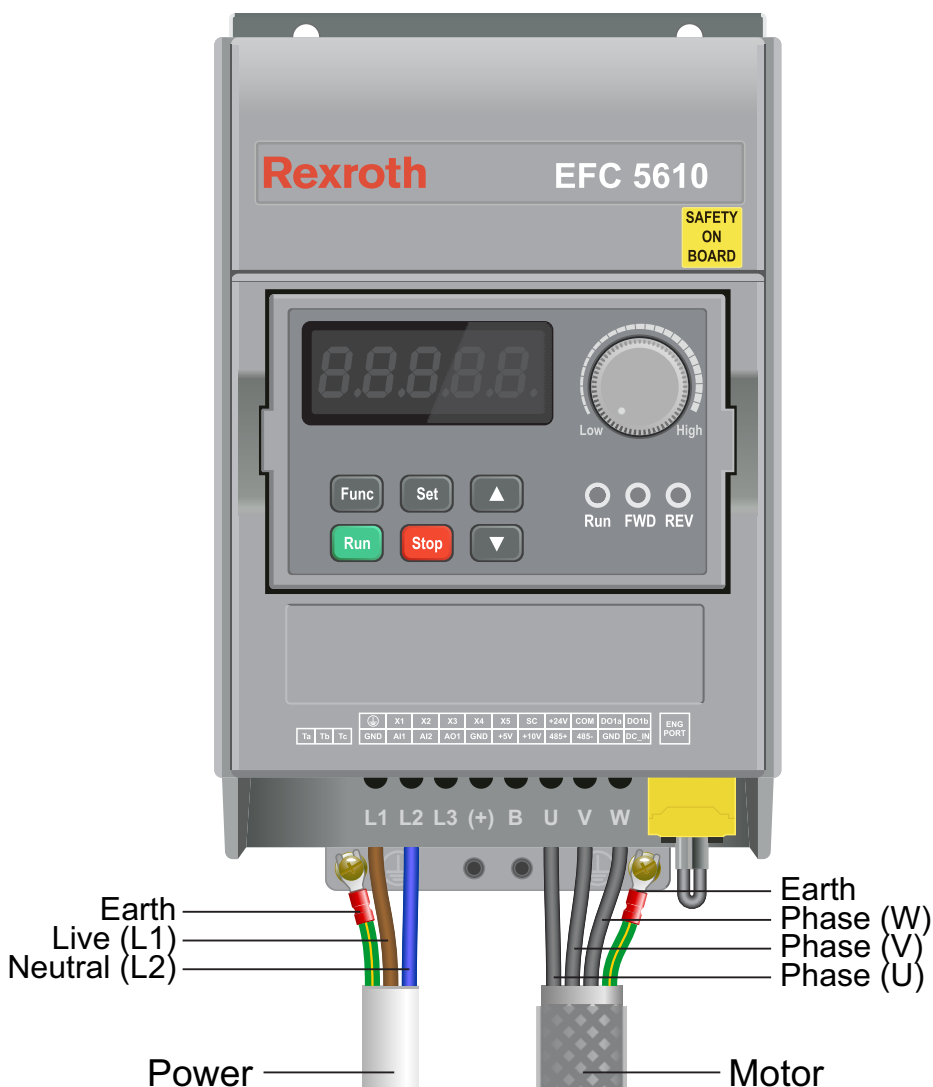

### Notes:

The illustration above is based on the 0.75kW 230V model. The terminal layout for other ratings is similar.

The order of the three motor phases determines the initial direction the motor turns.

### Important:

Use screened or armoured cable between the Inverter and Motor and ensure it is grounded as shown.

The motor must be separately earthed.

The supply must match the Inverter specification.

# Easy Start Guide

Bosch Rexroth EFC 5610 Series Inverter

## 2. Power and Motor Connections (Three Phase)



**Before commencing, confirm that the Inverter and all cables are completely isolated from the power supply, have been isolated for at least 5 minutes and that the motor is not turning.**

### Notes:

The illustration on the left is based on the 4kW 400V model. The terminal layout for other ratings is similar.

The order of the three supply phases is not important.

The order of the three motor phases determines the initial direction the motor turns. This can be reversed by physically swapping any two motor phases. Or by changing the Inverter parameters.

Use screened or armoured cable between the Inverter and Motor. To minimise electromagnetic interference, ensure the cable screen is grounded as shown.

The motor must be separately earthed.

The supply must match the Inverter specification.

## 3. Motor Connections - Star and Delta

Dual voltage induction motors typically include terminal boxes with six points. The points can be connected together with links in one of two ways to suit one of the two rated voltages.

The two ways of connecting the links are shown below. These are known as “Star” (the higher voltage) or “Delta” (the lower voltage).

**The selection of Star or Delta is not optional and must match the supply voltage.**

Dual voltage motor nameplates include symbols to represent voltage and full load current in each configuration.

Delta is represented by a triangle and star by a Y (Wye).

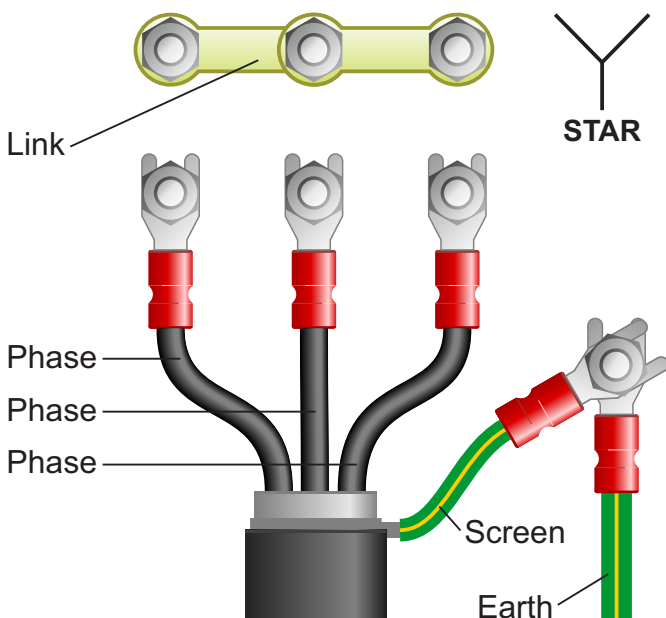

### 3.1 Motor connected in STAR (or Wye):

For safety purposes, Star (shown opposite) is the default configuration for small motors (usually to 3kW) and is sometimes known as “two at one side”.

Only two links are required for Star. Double-up the links if changing from Delta to allow the motor to be changed back in future.

The order of the three phases determines the direction the motor turns.

*Note that the manufacturer recommends that the cable screen is earthed at both ends and the motor and Inverter are earthed separately.*

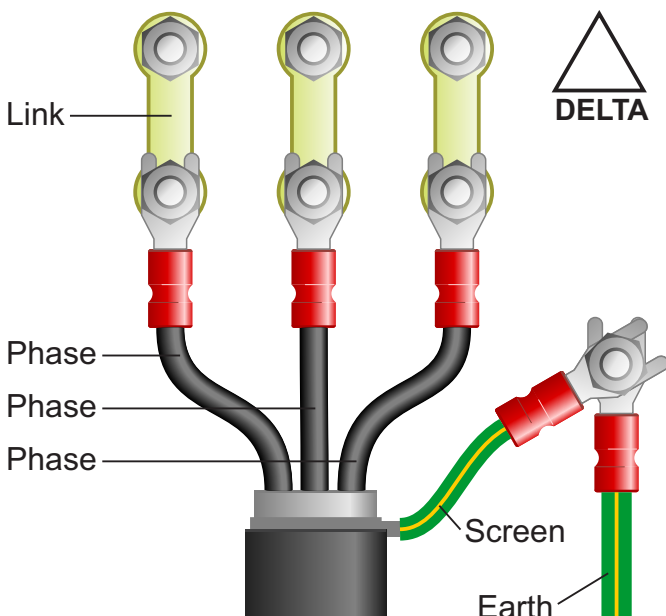

### 3.2 Motor connected in DELTA:

The link configuration is shown in the illustration opposite and is sometimes referred to as “three-a-breast”.

The order of the three phases determines the direction the motor turns.

*Note that the manufacturer recommends that the cable screen is earthed at both ends and the motor and Inverter are earthed separately.*

## 4. Parameters - overview

The Inverter contains a number of settings which can be changed to tailor it for use in a wide range of applications. These settings are known as parameters.

Parameters are typically referred to by code or number (eg. C1.07 = Rated Motor Current) with a description available in the manual.

The parameters contain critical information essential to the correct operation of the Inverter. Therefore, they should at least be checked by the user before the Inverter is operated for the first time.

The parameters listed in section 5 are intended to provide a starting point to allow for basic operation of the EFC 5610 Inverter.

## 5. Parameters to set before use

Set the following parameters to allow the EFC 5610 to control a motor with Run, Stop and Speed Control from the keypad.

If any of the parameters have been changed previously, follow the procedure in section 15 to reset the Inverter to Factory Defaults.

**See section 6 to learn how to set a parameter value.**

### 5.1 Parameters to check and values to set

Parameter	Description	How to set
b0.00	Access to additional parameters	Default is 0 for Basic Parameters. Set to <b>2</b> to enable Advanced Parameters.
E0.08	Maximum output frequency (Hz)	Maximum frequency of the <i>Inverter</i> . Default is <b>50.00</b> ; suitable for most applications.
E0.09	Output frequency high limit (Hz)	Maximum frequency of <i>speed reference</i> (eg. <i>keypad dial</i> ). Default is <b>50.00</b> ; suitable for most applications. Cannot be higher than E0.08.
E0.10	Output frequency low limit (Hz)	Default is 0.00; set to <b>05.00</b> for most applications .
E0.26	Acceleration time (s)	Default is rating dependent; set to <b>5</b> for most applications.
E0.27	Deceleration time (s)	Default is rating dependent; set to <b>5</b> for most applications.
C2.00	V/F curve mode	Default is <b>0</b> (linear); set to 1 if the motor is driving a Fan or Centrifugal Pump.
C1.05	Rated motor power (kW)	Set to match motor nameplate - eg. <b>0.8 (for 0.75kW)</b>
C1.06	Rated motor voltage (V)	Set to match motor nameplate - eg. <b>230</b>
C1.07	Rated motor current (A)	Set to match motor nameplate - eg. <b>3.34</b>
C1.08	Rated motor frequency (Hz)	Default is 50.00. Change to 60.00 for 60Hz motor only - otherwise set at <b>50.00</b>
C1.09	Rated motor speed (rpm)	Set to match motor nameplate - eg. <b>1380</b>
C0.05	Carrier frequency (Hz)	Default is rating dependent and will suit most applications. Increasing Carrier frequency may reduce motor noise.

## 6. How to set a Parameter value



### 6.1 Find Parameter Groups.

This example demonstrates the steps required to set parameter E0.26 which is Acceleration time in seconds.

Press the “Func” key repeatedly until the display shows “-b0-” (shown in the illustration opposite). Use the up and down keys to cycle through the parameter groups.



### 6.2 Find a Parameter Group eg. E0

There are a total of 17 parameter groups when “Advanced Parameters” are enabled:-



Some parameter groups may be hidden when “Advanced Parameters” are not enabled. Press “Set” to select “-E0-”.



### 6.3 Find a Parameter eg. E0.26

The display will show “E0.00” to indicate parameter 00 within group E0.

Use the up and down keys to navigate to parameter E0.26. Press the “Set” key to modify the parameter value.

Note that in some cases, the value of a parameter can be restricted by the value of another parameter.



### 6.4 Change a Parameter value.

Use the up and down keys to increase or decrease the value. Press and hold the up or down key to change the value more quickly.

Press the “Set” key to save changes. The display will show the next available parameter. Press “Func” twice to exit.

*Note: If the keypad is not used for more than 30 seconds the display will return to the set point value.*

## 7. How to operate the Inverter from the keypad



### 7.1 Use the dial to set the required speed.

When the EFC5610 is powered up for the first time without any changes to the parameters it will operate from the keypad. The display will change to show the speed reference in Hz. This is set (as default) by the pot on the keypad.

The minimum speed reference is defined by parameter E0.10 and the maximum reference by E0.09.



### 7.2 Press the green "Run" button to start the motor.

Press the green button firmly to start the motor. The motor will accelerate to the speed set in 7.1 (above) in the time defined by parameter E0.26. The display will increase from 0.00 to the speed reference.

Motor speed can be changed whilst the motor is running by rotating the dial clockwise (faster) or anti-clockwise (slower). When running, the "Run" lamp will be illuminated.



### 7.3 Press the red "Stop" button to stop the motor.

The red button will stop the motor. The display will decrease from the current speed to 0.00. When stopped, the "Run" lamp will go out and the display will return to the speed reference value.

The time taken (in seconds) to stop the motor is determined by parameter E0.27.



## 8. How to enable Sensorless Vector Mode

The standard motor control mode of the EFC5610 Inverter is VxF. This simple mode controls motor speed by varying Volts and Frequency in a specific ratio to maintain output torque.

The EFC5610 can also operate in Sensorless Vector mode. This can improve motor performance without requiring a separate feedback device. Sensorless Vector mode operates in a similar way as VxF but performs a number of calculations to improve low speed torque.

These calculations require a rotating “autotune” run with bare shaft during which the Inverter operates for approx. 30s to gather the necessary data.

For loads that cannot be decoupled from the motor, a stationary Autotune (set C1.01 to 1 instead of 2) is possible but is not as accurate. A rotating Autotune is therefore the preferred option.

To enable sensorless vector control first set the parameter values specified in 8.1 and then follow the steps described in 8.2 and 8.3.

### 8.1 Parameters to check prior to an Autotune.

Parameter	Description	How to set
b0.00	Access to additional parameters	Default is 0 for Basic Parameters. Set to 2 to enable Advanced Parameters.
C1.05 to C1.09	Motor parameters	Must be set correctly before Sensorless vector control is enabled. Refer to section 5 for details.



### 8.2 Start Autotune.

Once the parameters in 8.1 have been set, select parameter C1.01 and change the value to 2 and press “Set” to save the changes.

Press the “Func” key repeatedly until the speed reference is displayed.

Ensure that the motor is decoupled from the load before pressing the green “Run” button to begin the autotuning process.



### 8.3 The Autotune process.

During the autotuning process, the display will show “tUnE”.

When the process is complete the motor will stop, the “run” lamp will no longer be illuminated and the display will return to the speed reference. The results are saved in parameters C1.12 to C1.14 and C1.20 to C1.24 but sensorless vector mode is not enabled automatically.

**Important: To enable sensorless vector mode once the autotune is complete set parameter C0.00 to 1.**

## 9. How to connect and configure a Potentiometer for remote speed control

If the integrated dial on the keypad is unsuitable for the application, a remote Potentiometer can be used instead.

This provides the benefit of allowing motor speed to be controlled from a more convenient location such as a cabinet door (if the EFC 5610 is cabinet-mounted) or on the machine itself.

A Potentiometer of **10kOhm** rating should be used.

The number of turns depends on the application but both single turn and ten turn Potentiometers are available from The Inverter Drive Supermarket at [InverterDrive.com](http://InverterDrive.com).

### 9.1 Relevant parameters for remote Potentiometer speed control

Parameter	Description	How to set
b0.00	Access to additional parameters	Default is 0 for Basic Parameters. Set to 2 to enable Advanced Parameters.
E0.00	Frequency Setting Source	Default is 0 for keypad dial; set to 2 for terminal (remote) control via AI1.
E1.35	AI1 input mode	Default is 2 for 0-10V; default is required for this example.

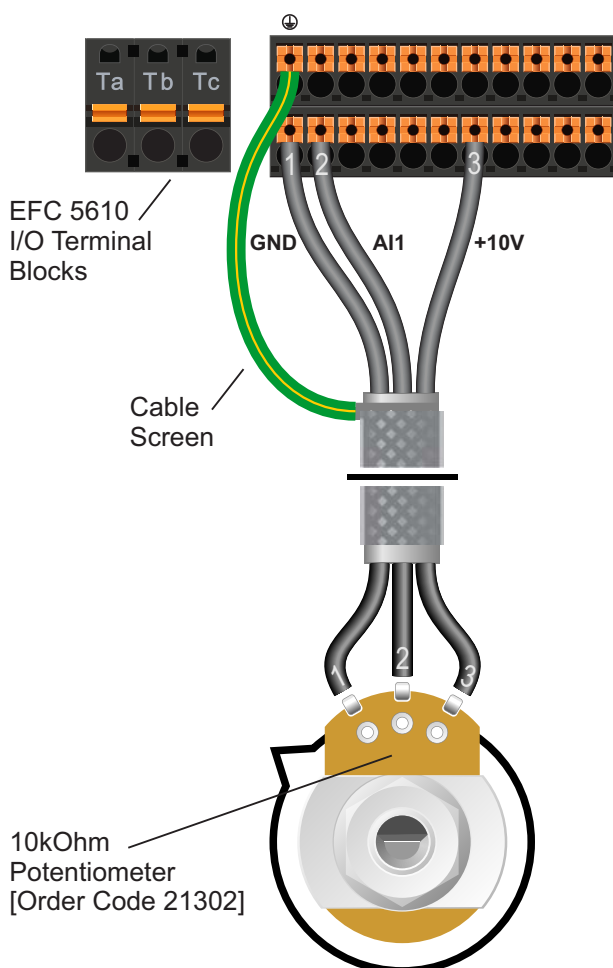

### 9.2 Connecting the Potentiometer

A wiring diagram is shown in the illustration opposite. The most important connection at the Potentiometer end is the centre terminal or "wiper".

The wiper will output a variable voltage between 0 and 10 volts and should be connected to the AI1 terminal at the Inverter end. It is this voltage which provides the speed signal with 0V being slowest and 10V fastest.

The default output frequency at 0V is 0Hz and at 10V is 50Hz.

If the rotation of the Potentiometer is the opposite to that required (ie. turn anti-clockwise to increase speed instead of clockwise) reverse connections +10V and GND.

Use shielded cable between Potentiometer and Inverter and ensure that the cable screen is connected to the Inverter earth terminal only.

## 10. How to connect and configure a Run Forward or Run Reverse switch

The parameters described in Section 5 enable Run/Stop operation via the red and green buttons on the Inverter.

If this is unsuitable for the application, a remote switch can be used instead.

This section explains how to enable 2-wire control with Run Forward / Stop / Run Reverse commands via a single selector switch.

Note that once this procedure is complete, the Run/Stop buttons on the Inverter can no longer be used.

### 10.1 Relevant parameters for remote Run/Stop

Parameter	Description	How to set
b0.00	Access to additional parameters	Default is 0 for Basic Parameters. Set to 2 to enable Advanced Parameters.
E0.01	First run command source	Default is 0 for keypad. Set to 1 for terminal control on the Inverter. When set to 1, the FWD lamp will go out.
E1.00	X1 input	Default is 35 for Forward Run; default is required for this example.
E1.01	X2 input	Default is 36 for Reverse Run; default is required for this example.
E1.15	2-wire / 3-wire control mode	Default is 0 for 2-wire forward / stop, reverse / stop; default is required for this example.

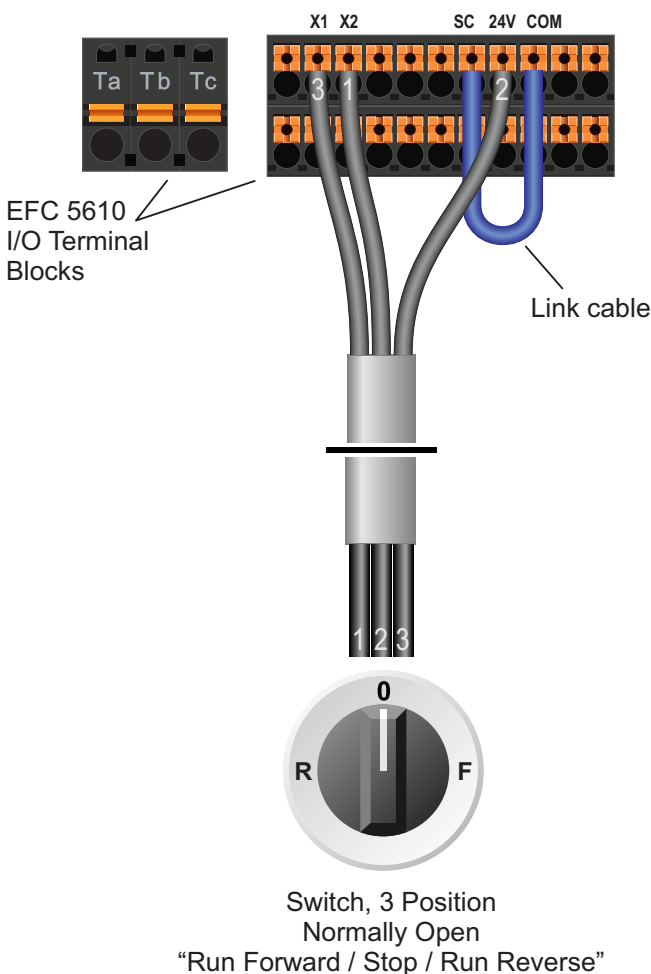

### 10.2 Connecting the Switch

A wiring diagram is shown in the illustration opposite. The SC and COM terminals must be linked.

A suitable 3 position NO (Normally Open) switch should be installed between terminals 24V, X1 and X2. The centre position should remain open circuit.

When run forward is selected (24V to X1) the motor will accelerate from 0 to the currently-selected speed set point. Run and Fwd lamps will illuminate. When run reverse is selected (24V to X2) the behavior is the same but the motor will run in reverse and the Rev lamp will illuminate instead of Fwd.

When stop is selected (open circuit) the motor will decelerate to zero and the Run and Fwd lamps will go out. The display will revert to the current setpoint.

## 11. How to connect and configure a Run/Stop switch with Forward/Reverse selection

The parameters described in Section 5 enable Run/Stop operation via the red and green buttons on the Inverter.

If this is unsuitable for the application, remote switches can be used instead.

This section explains how to enable 2-wire control with Run/Stop and Forward/Reverse commands via separate selector switches.

Note that once this procedure is complete, the Run/Stop buttons on the Inverter can no longer be used.

### 11.1 Relevant parameters for remote Run/Stop

Parameter	Description	How to set
b0.00	Access to additional parameters	Default is 0 for Basic Parameters. Set to 2 to enable Advanced Parameters.
E0.01	First run command source	Default is 0 for keypad. Set to 1 for terminal control on the Inverter
E1.00	X1 input	Default is 35 for Forward Run; default is required for this example.
E1.01	X2 input	Default is 36 for Reverse Run; default is required for this example.
E1.15	2-wire / 3-wire control mode	Default is 0. Set to 1 for 2-wire forward / reverse, run / stop.

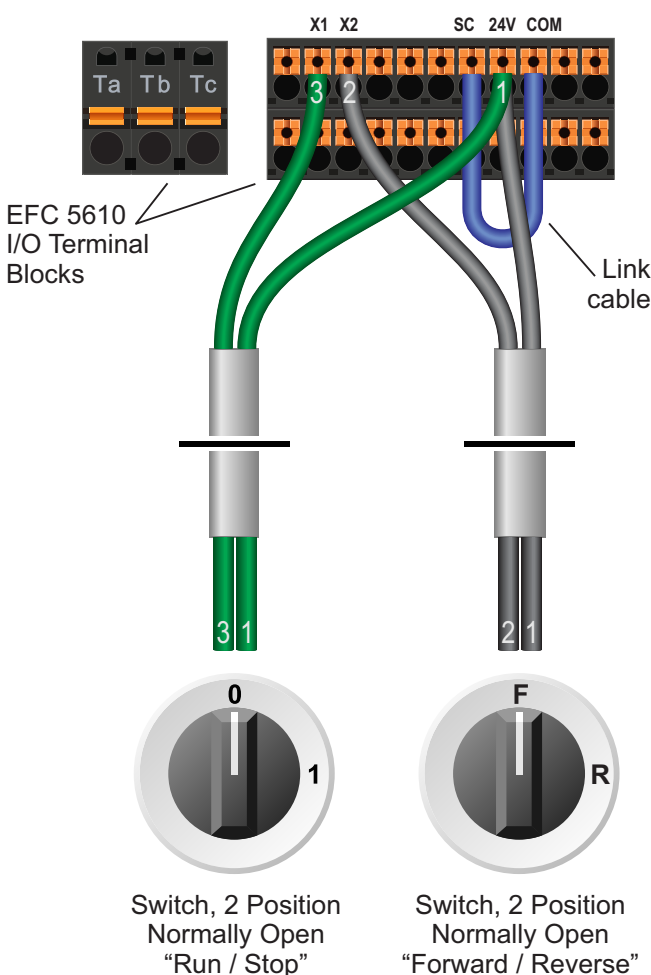

### 11.2 Connecting the Switches

A wiring diagram is shown in the illustration opposite. The SC and COM terminals must be linked.

Two suitable 2 position NO (Normally Open) switches should be installed: One between terminals 24V and X1 (Run/Stop) and the other between terminals 24V and X2 (Forward/Reverse).

When run is selected (24V to X1) and forward is selected (X1 open circuit) the display will increase from 0 to the speed reference as the motor accelerates and the run lamp will illuminate.

When stop is selected (X1 open circuit) the display will decrease to zero as the motor decelerates. Once at zero, the run lamp will go out. The display will then revert to the speed reference.

*Note: the Forward/Reverse switch only selects the direction of rotation - it will not start or stop the motor.*

If the application only requires the motor to turn in one direction, the Forward/Reverse switch can be omitted.

## 12. How to configure “3-Wire” control with Run/Stop pushbuttons and Forward/Reverse selection

The parameters described in Section 5 enable Run/Stop operation via the red and green buttons on the Inverter.

If this is unsuitable for the application, remote switches can be used instead.

This section explains how to enable 3-wire control with Run and Stop commands via separate pushbuttons and Forward/Reverse selection via a selector switch. Note that once this procedure is complete, the Run/Stop buttons on the Inverter can no longer be used.

### 12.1 Relevant parameters for remote 3-wire control

Parameter	Description	How to set
b0.00	Access to additional parameters	Default is 0 for Basic Parameters. Set to 2 to enable Advanced Parameters.
E0.01	First run command source	Default is 0 for keypad. Set to 1 for terminal control on the Inverter
E1.00	X1 input	Default is 35 for Forward Run; default is required for this example.
E1.01	X2 input	Default is 36 for Reverse Run; default is required for this example.
E1.02	X3 input	Default is 0; set to 25 to select 3 wire control with reverse select
E1.15	2-wire / 3-wire control mode	Default is 0. Set to 2 for 3-wire control mode. If the Inverter displays a PrSE error (conflict) ensure that parameters E1.00 to E1.02 (see above) have been set first.

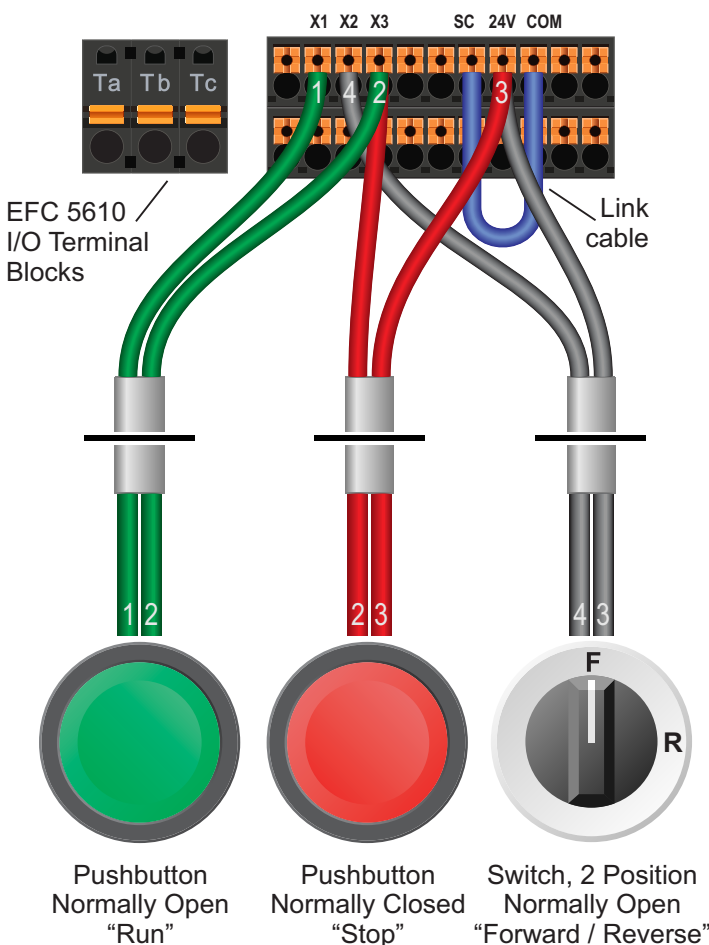

### 12.2 Connecting the Switches

A wiring diagram is shown in the illustration opposite. The SC and COM terminals must be linked.

For “Run” and “Stop”, two suitable pushbuttons should be installed. The “Run” pushbutton should include a Normally Open contact between terminals X1 and X3 and the “Stop” a Normally Closed contact between terminals 24V and X3.

For “Forward/Reverse” a suitable 2 position NO (Normally Open) switch should be installed between terminals 24V and X2.

A momentary connection between X1 and X3 will start the motor. It will continue to run until the connection between 24V and X3 is broken.

Note that the Forward/Reverse switch only selects the direction of rotation - it will not start or stop the motor. If the application only requires the motor to turn in one direction, the Forward/Reverse switch can be omitted.



## 13. Brake Resistor Connection



**Before commencing, confirm that the Inverter and all cables are completely isolated from the power supply, have been isolated for at least 5 minutes and that the motor is not turning.**

High inertia loads can cause overvoltage trips during deceleration and lead to “OE-3” error messages. In many cases, the solution is to increase the deceleration time to compensate.

However, if the application requires it, dynamic braking can be enabled to maintain or reduce deceleration times by absorbing the energy generated by such loads.

A Brake Resistor is first installed to absorb braking energy and dissipate it as heat. The resistor must be correctly sized for both the Inverter and application.

Then, the “brake chopper” within the Inverter is enabled. This detects excessive braking energy and redirects it to the resistor when required.

### 13.1 Relevant parameters for Dynamic Braking

Parameter	Description	How to set
b0.00	Access to additional parameters	Default is 0 for Basic Parameters. Set to 2 to enable Advanced Parameters.
C0.25	Overvoltage prevention mode	Default is 3 for Stall overvoltage protection enabled, resistor braking enabled; default is required for this example.

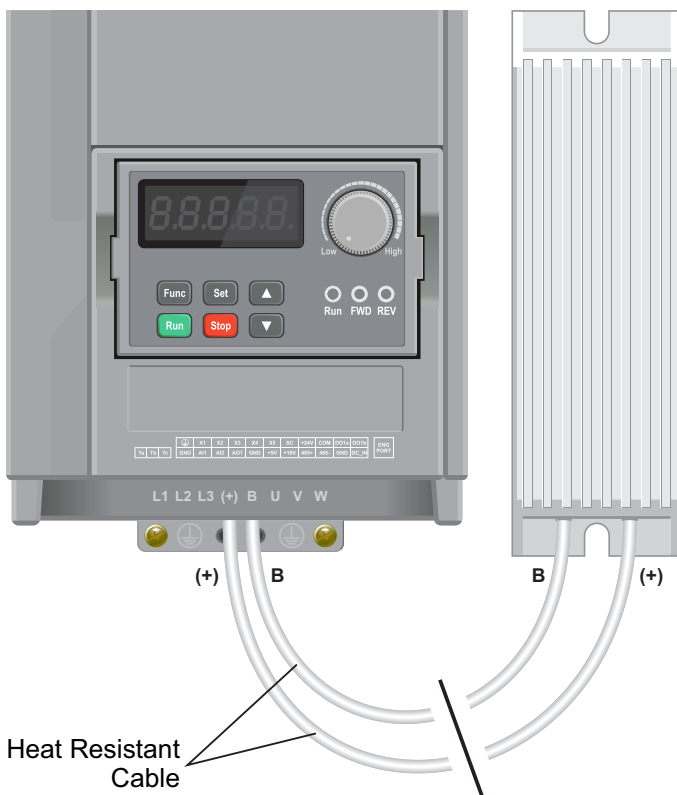

### 13.2 Connecting the Resistor

A wiring diagram is shown in the illustration opposite. Connect the brake resistor to the B and (+) Terminals on the Inverter. The order of the connections is unimportant.

The braking resistor may get hot during operation. Ensure that it is mounted in a suitable position at least 10cm away from other items.

It is important that a resistor of the correct rating is used. Consult the manufacturer’s manual or product listing on [InverterDrive.com](http://InverterDrive.com) for further information.

## 14. STO (Safe Torque Off) Connections



**This section is an overview only. You must also refer to the manual provided by the manufacturer for full details of STO functionality.**

Safe Torque Off (STO) is an optional safety feature included with some EFC5610 Inverters. If present, the Inverter will include a yellow STO connector. No parameter changes are required to enable this feature.

STO provides a facility to disable the output of the Inverter so that the motor it is controlling cannot be operated ie. that no torque can be applied. However, it does not provide any form of braking so will not prevent the load from rotating the motor.

The STO function is only effective when wired to suitable safety devices that detect an 'unsafe' situation. A safety assessment of the machinery is required by suitably qualified personnel to identify what should be considered 'unsafe' and what safety devices are appropriate for the application.

It is not recommend to stop a motor using the Inverter STO function. The motor should be stopped before STO is activated or an **Sto-r** error message will be displayed.

STO does not isolate the electrical supply. Therefore, the Inverter must be isolated from the supply before any maintenance is carried out.

### 14.1 STO Links (STO disabled, as supplied)

The Inverter is supplied with links configured so that the Inverter can be used with STO disabled. The illustration on the right shows this arrangement. The links simply connect STO channels 1 and 2 to 24V and common.

If STO is to be used, remove all links.

There are 12 terminals on the STO plug which are bridged for easy connection. Therefore, either the top 6 or bottom 6 can be used.

### 14.2 STO Enabled

When enabled, the STO channels are connected to the external safety devices. The manufacturer recommends that a suitable external 24V power supply is used instead of the +24V and COM terminals on the Inverter.

When the Inverter is powered up, 24V must be present on both STO channels or an **Sto-A** alarm will be displayed and the motor will not operate.

If 24V is lost on one channel an **Sto-E** error message will be displayed.

#### STO Disabled

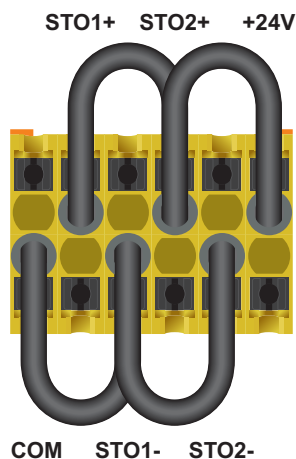

#### STO Enabled

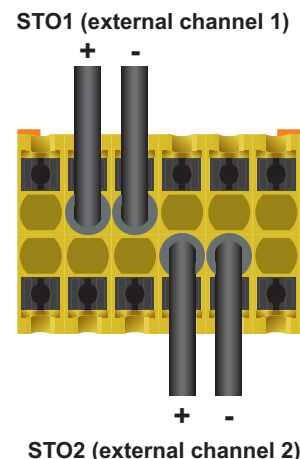

This display will flash StO-A and the motor will not start if 24V is not present on both STO channels

## 15. How to reset the Inverter to Factory Defaults



### 15.1 Select the b0 Parameter Group

With the motor stopped, press the “Func” button repeatedly until the display shows “-b0-” (do not press and hold the “Func” button).



### 15.2 Select Parameter b0.10.

Press the “Set” button to select the b0 Parameter group then use the up button to locate parameter b0.10.



### 15.3 Change value of b0.10 from 0 to 1.

Press the “Set” button to edit the value of b0.10 and use the up button to change this from 0 to 1.

Press the “Set” button again to save the changes.



### 15.4 Finished

The display will show the next parameter for editing (b0.11).

Press the “Function” button twice to exit from the parameter menu.

*Optional: repeat the process and change b0.10 from 0 to 2 to clear recent fault messages if required.*