Instruction Manual

General application Inverter

IMO iDrive2 XKL

CAUTION

Thank you for purchasing our iDrive2 XKL series of inverters.

- This product is designed to drive a three-phase induction motor. Read through this instruction manual and be familiar with the handling procedure for correct use.
- Improper handling might result in incorrect operation, a short life, or even a failure of this product as well as the motor.
- Deliver this manual to the end user of this product. Keep this manual in a safe place until this product is discarded.
- For how to use an optional device, refer to the instruction and installation manuals for that optional device.

Copyright © 2015 IMO Precision Controls Ltd
All rights reserved.

No part of this publication may be reproduced or copied without prior written permission from IMO Precision Controls Ltd.

All products and company names mentioned in this manual are trademarks or registered trademarks of their respective holders.

The information contained herein is subject to change without prior notice for improvement.

Content	
1 Safety Precautions.....	4
1.1 Safety definition	4
1.2 Warning symbols	4
1.3 Safety guidelines	4
2 Product overview	7
2.1 Quick start-up	7
2.2 Product specification.....	8
2.3 Name plate	10
2.4 Type designation key	10
2.5 Rated specifications.....	10
2.6 Structure diagram	10
3 Installation Guidelines.....	12
3.1 Mechanical installation.....	12
3.2 Standard wiring	14
3.3 Layout protection	16
4 Keypad Operation Procedure	18
4.1 Keypad displaying.....	19
4.2 Keypad operation.....	20
5 Function Parameters	22
6 Fault tracking	65
6.1 Maintenance intervals.....	65
6.2 Fault solution	68
7 Communication protocol	71
7.1 Brief instruction to Modbus protocol.....	71
7.2 Application of the inverter.....	71
7.3 RTU command code and communication data illustration	75
Appendix A Technical data	84
A.1 Ratings	84
A.2 CE	84
A.3 EMC regulations.....	85
Appendix B Dimension drawings	86
B.1 Keypad structure	86
B.2 Inverter chart	86
Appendix C Peripheral options and parts	87
C.1 Peripheral wiring.....	87
C.2 Power supply.....	88
C.3 Cables	88
C.4 Breaker and electromagnetic contactor.....	88
C.5 Reactors.....	89
C.6 Filter	89
C.7 Braking system.....	90
Appendix D Further information	92

1 Safety Precautions

Please read this manual carefully and follow all safety precautions before moving, installing, operating and servicing the inverter. If ignored, physical injury or death may occur, or damage may occur to the devices.









IMO are not responsible for any physical injury or death to persons or damage to the devices if the safety precautions in the manual are not complied with.

1.1 Safety definition



Danger:	Serious physical injury or even death may occur if Danger safety requirements are not followed.
Warning:	Physical injury or damage to the devices may occur if Warning safety requirements are not followed.
Note:	Physical injury may occur if above instructions are ignored.
Qualified electricians:	Only qualified Engineers with extensive knowledge and experience of commissioning and installation should attempt to install these devices. All safety precautions must be taken when installing.

1.2 Warning symbols

Warnings caution you about conditions which can result in serious injury or death and/or damage to the equipment, and advice on how to avoid the danger. The following warning symbols are used in this manual:

Symbols	Name	Instruction	Abbreviation
 Danger	Danger	Serious physical injury or even death may occur if requirements are not followed.	
 Warning	Warning	Physical injury or damage to the devices may occur if requirements are not followed.	
 Do not	Electrostatic discharge	Damage to the PCBA board may occur if requirements are not followed.	
 Hot sides	Hot sides	Sides of the device may become hot. Do not touch.	
Note	Note	Physical injury may occur if requirements are not followed.	Note

1.3 Safety guidelines

	<p>◇ Only qualified electricians are allowed to operate on the inverter.</p> <p>◇ Do not perform any wiring and inspection or changing components when the power supply is applied. Ensure all input power supply is disconnected before wiring and checking and always wait for at least the time designated on the inverter or until the DC bus voltage is less than 36V. Below is the table of the waiting time:</p> <table border="1"> <thead> <tr> <th colspan="2">Inverter module</th> <th>Minimum waiting time</th> </tr> </thead> <tbody> <tr> <td>Single-phase 230V</td> <td>0.4kW-2.2kW</td> <td>5 minutes</td> </tr> <tr> <td>Three-phase 400V</td> <td>0.75kW-2.2kW</td> <td>5 minutes</td> </tr> </tbody> </table>	Inverter module		Minimum waiting time	Single-phase 230V	0.4kW-2.2kW	5 minutes	Three-phase 400V	0.75kW-2.2kW	5 minutes
Inverter module		Minimum waiting time								
Single-phase 230V	0.4kW-2.2kW	5 minutes								
Three-phase 400V	0.75kW-2.2kW	5 minutes								
	◇ Install the inverter according to manual; otherwise fire, electric shock or other injury may occur.									
	◇ The base of the heatsink may become hot during running. Do not touch to avoid injury.									

	<ul style="list-style-type: none"> ✧ The electrical parts and components inside the inverter are electrostatic. Take precautions to avoid electrostatic discharge during relevant operation.
---	---

1.3.1 Delivery and installation

	<ul style="list-style-type: none"> ✧ Please install the inverter on fire-retardant material and keep the inverter away from combustible materials. ✧ Connect the optional braking components (braking resistors) according to the wiring diagram. ✧ Do not operate on the inverter if there is any damage or components loss to the inverter. ✧ Do not touch the inverter with wet items or body, risk of electric shock.
---	---

Note:

- ✧ Select appropriate moving and installing tools to ensure a safe and normal running of the inverter and avoid physical injury or death. For physical safety, the installer should take some mechanical protective measurements, such as wearing exposure shoes and working uniforms.
- ✧ Protect against physical damage or vibration during delivery and installation.
- ✧ Do not carry the inverter by its cover.
- ✧ Install away from children and other public places.
- ✧ The inverter cannot meet the requirements of low voltage protection in IEC61800-5-1 if the sea level of installation site is above 2000m.
- ✧ The Earth leakage current of the inverter may be above 3.5mA during operation. Ground with proper techniques and ensure the grounding resistor is less than 10Ω. The conductivity of PE grounding conductor is the same as that of the phase conductor (with the same cross sectional area).
- ✧ R, S and T are the input terminals of the power supply, while U, V and W are the motor terminals. Please connect the input power cables and motor cables correctly; otherwise the damage to the inverter may occur.

1.3.2 Commissioning and running

	<ul style="list-style-type: none"> ✧ Disconnect all power supplies applied to the inverter before the terminal wiring and wait for at least the designated time after disconnecting the power supply. ✧ High voltage is present inside the inverter during running. Do not carry out any operation except for the keypad setting. ✧ The inverter may auto start when P01.21=1. Do not get close to the inverter and motor. ✧ The inverter cannot be used as “Emergency-stop device”. ✧ The inverter cannot be used to brake the motor suddenly. A mechanical braking device should be used.
---	--

Note:

- ✧ Do not switch on/off the input power supply of the inverter frequently.
- ✧ For inverters that have been stored for a long time, check and fix the capacitance and try to run it again before use (see Maintenance and Hardware Fault Diagnosis).
- ✧ Replace top cover before running, otherwise electric shock may occur.

1.3.3 Maintenance and replacement of components

	<ul style="list-style-type: none"> ✧ Only qualified electricians should perform the maintenance, inspection, and components replacement of the inverter. ✧ Disconnect all power supplies to the inverter before the terminal wiring. Wait for at least the
---	--

	<p>time designated on the inverter after disconnection.</p> <ul style="list-style-type: none">✧ Take measures to avoid screws, cables and other conductive matters to falling into the inverter during maintenance and component replacement.
--	---

Note:

- ✧ Ensure screws are tightened to the correct torque.
- ✧ Keep the inverter, parts and components away from combustible materials during maintenance and component replacement.
- ✧ Do not perform any isolation and pressure test on the inverter and do not perform a megger test on the inverter.

1.3.4 What to do after scrapping

	<ul style="list-style-type: none">✧ The inverter contains hazardous materials. Dispose of according to WEEE regulations.
---	--

2 Product overview

2.1 Quick start-up

2.1.1 Unpacking inspection

Check as followings after receiving products:

- | |
|--|
| 1. Check that there is no physical or water damage to the package. Contact supplier immediately if received damaged. |
| 2. Check the information on the type designation label on the outside of the package to verify that the drive is of the correct type. If not, contact supplier immediately. |
| 3. Check that there are no signs of water in the package and no signs of damage or breach to the inverter. Contact supplier immediately if any damage. |
| 4. Check the information on the type designation label on the outside of the package to verify that the name plate is of the correct type. If not, contact supplier immediately. |
| 5. Check to ensure the accessories (including user's manual and control keypad) inside the device is complete. If not, contact supplier immediately. |

2.1.2 Application confirmation

Check the machine before beginning to use the inverter:

- | |
|---|
| 1. Check the load type to verify that there is no overload of the inverter during work and check the drive is the correct power rating. |
| 2. Check that the actual current of the motor is equal to or less than the rated current of the inverter. |
| 3. Check that the control accuracy of the load is the same of the inverter. |
| 4. Check that the incoming supply voltage is correspondent to the rated voltage of the inverter. |

2.1.3 Environment

Check as followings before the actual installation and usage:

- | |
|--|
| 1. Check that the ambient temperature of the inverter is below 40°C. If exceeds, derate 3% for every additional 1°C. Additionally, the inverter can not be used if the ambient temperature is above 50°C.
Note: for the cabinet inverter, the ambient temperature means the air temperature inside the cabinet. |
| 2. Check that the ambient temperature of the inverter in actual usage is above -10°C. If not, add heating facilities.
Note: for the cabinet inverter, the ambient temperature means the air temperature inside the cabinet. |
| 3. Check that the altitude of the actual usage site is below 1000m. If exceeds, derate 1% for every additional 100m. |
| 4. Check that the humidity of the actual usage site is below 90% and condensation is not allowed. If not, add additional ant-condensation heaters. |
| 5. Check that the actual usage site is away from direct sunlight and foreign objects can not enter the inverter. If not, add additional protective measures. |
| 6. Check that there is no conductive dust or flammable gas in the vicinity of the drive. If not, add additional protection to inverters. |

2.1.4 Installation confirmation

Check as followings after the installation:

- | |
|---|
| 1. Check that the load range of the input and output cables meet the need of actual load. |
|---|

2. Check that the accessories of the inverter are correctly and properly installed. The installation cables should meet the needs of every component (including reactors, input filters, output reactors, output filters, DC reactors and braking resistors).
3. Check that the inverter is installed on non-flammable materials and the calorific accessories (reactors and brake resistors) are away from flammable materials.
4. Check that all control cables and power cables are run separately and the routed to comply with EMC requirements.
5. Check that all grounding systems are properly grounded according to the requirements of the inverter.
6. Check that the free space during installation is sufficient according to the instructions in user's manual.
7. Check that the installation conforms to the instructions in user's manual. The drive must be installed in an upright position.
8. Check that the external connection terminals are tightly fastened and the torque is appropriate.
9. Check that there are no screws, cables and other conductive items left in the inverter.

2.1.5 Basic commissioning

Complete the basic commissioning as follows before actual operation:

1. Autotune. If possible, de-coupled from the motor load to start dynamic autotune. Or if not, static autotune is available.
2. Adjust the ACC/DEC time according to the actual running of the load.
3. Commission the device via jogging and check that the rotation direction is as required. If not, change the rotation direction by changing the wiring of motor.
4. Set all control parameters to suit application.

2.2 Product specification

Function		Specification
Power input	Input voltage (V)	Single-phase 220 (-15%)~240 (+10%) Three-phase 380 (-15%)~440 (+10%)
	Input current (A)	Refer to table 2.5
	Input frequency (Hz)	50Hz or 60Hz Allowed range: 47~63Hz
Power output	Output voltage (V)	=the input voltage (error<5%)
	Output current (A)	Refer to table 2.5
	Output power (kW)	Refer to table 2.5
	Output frequency (Hz)	50Hz/60Hz, fluctuation:±5%
Technical control	Control mode	V/F
	Maximum output frequency	400Hz
	Adjustable-speed ratio	1:100
	Overload capability	150% of rated current: 1 minute 180% of rated current: 10 seconds 200% of rated current: 1 second
Running control	Key functions	Stop mode and anti-temperature of the bus
	Temperature measurement accuracy	Overtemperature point ±3°C
	Terminal switch input	≤ 2ms

	Function	Specification
	resolution	
	Terminal analog input resolution	≤ 20mV
	Analog input	1 input 0~10V/0~20mA
	Analog output	1 input 0~10V/0~20mA
	Digital input	5 common input
	Digital output	1 Y output (commonly used with digital output) and 1 programmable relay output
	Communication	485 communication
	Frequency setting	Digital setting, analog setting, multi-step speed setting, PID setting, MODBUS communication setting and so on Switch between different settings
	Automatic voltage adjustment	Keeps output voltage stable when the grid voltage changes
	Fault protection	More than 10 fault protections
Others	Mountable method	Wall mountable
	Temperature of the running environment	-10~50°C, derate above 40°C
	Cooling	Single/three-phase 230V 0.2-0.75kW natural cooling Single/three-phase 230V 1.5-2.2kW, three-phase 380V 0.75-2.2kW
	Enclosure	IP20
	Braking unit	Embedded
	DC reactor	Not optional
	Braking resistor	Optional and external
	Optional EMC filters	C2 or C3 filter options

2.3 Name plate

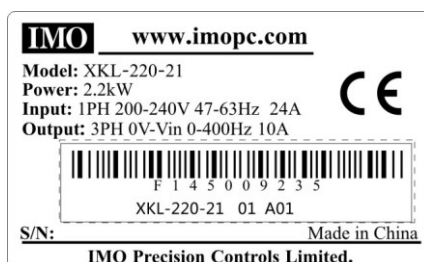

Fig 2-1 Name plate

2.4 Type designation key

The type designation contains information on the inverter. The user can find the type designation on the type designation label attached to the inverter or the simple name plate.

XKL - 220 - 2 1

① ② ③ ④

Fig 2-2 Product type

Field identification	Sign	Detailed description of the sign	Detailed content
Abbreviation	①	Product abbreviation	Series = XKL
Rated power	②	Power range	220 = 2.2kW
Voltage	③	Supply voltage	4: 380 (-15%)~440 (+10%) 2: 220 (-15%)~240 (+10%)
Phase	④	Input Phase	1 = 1Phase 3 = 3Phase

2.5 Rated specifications

	Model	Output power (kW)	Input current (A)	Output current (A)
Single-phase 230V	XKL-040-21	0.4	6.5	2.5
	XKL-075-21	0.75	9.3	4.2
	XKL-150-21	1.5	15.7	7.5
	XKL-220-21	2.2	24	10
Three-phase 400V	XKL-075-43	0.75	3.2	2.5
	XKL-150-43	1.5	4.3	4.2
	XKL-220-43	2.2	7.1	5.5

2.6 Structure diagram

Below is the layout figure of the inverter (take the inverter of 2.2kW as the example).

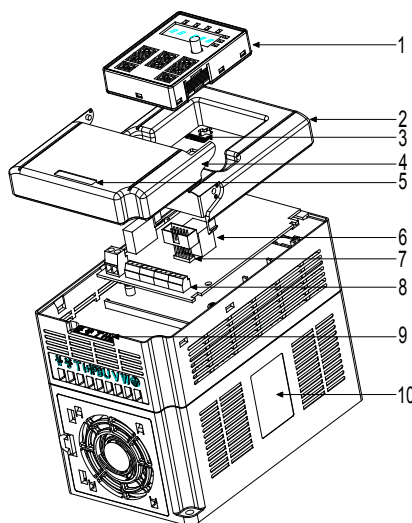



Fig 2-3 Product structure diagram

Serial No.	Name	Illustration
1	Keypad	See Keypad Operation Procedure for detailed information
2	Cover	Protects the internal parts and components
3	POWER indicator	POWER indicator
4	Side cover	Protects the internal components
5	Simple name plate	See Type Designation Key for detailed information
6	Keypad port	Connect the keypad
7		6 is for external installation
8	Main circuit terminals	See Electric Installation for detailed information
9	Control circuit terminals	See Electric Installation for detailed information
10	Name plate	See Product Overview for detailed information

3 Installation Guidelines

This chapter describes the mechanical installation and electric installation.

	<ul style="list-style-type: none"> ✧ Only qualified electricians are allowed to carry out what described in this chapter. Please operate as the instructions in Safety Precautions. Ignoring these may cause physical injury or death or damage to the devices. ✧ Ensure the power supply of the inverter is disconnected during the operation. Wait for at least the time designated until the POWER indicator is off after the disconnection if the power supply is applied. ✧ The installation and design of the inverter should be comply with the requirement of the local laws and regulations at the installation site. If the installation infringes the requirement, IMO will exempt from any responsibility. Additionally, if users do not comply with the recommendation, some damage beyond the assured maintenance range may occur.
---	---

3.1 Mechanical installation

3.1.1 Installation environment

The installation environment is the safeguard for a full performance and long-term operation of the inverter. Check the installation environment as following:

Environment	Conditions
Installation site	Indoor
Environment temperature	<p>-10°C ~+40°C, and the temperature changing rate is less than 0.5°C/minute.</p> <p>If the ambient temperature of the inverter is above 40°C, derate 3% for every additional 1°C.</p> <p>It is not recommended to use the inverter if the ambient temperature is above 60°C.</p> <p>In order to improve the reliability of the device, do not use the inverter if the ambient temperature changes frequently.</p> <p>Please provide cooling fan or air conditioner to control the internal ambient temperature below the max limit if the inverter is used in a close space such as in a control cabinet.</p> <p>When the temperature is too low, if the inverter needs to restart to run after a long stop, it is necessary to provide an external heating device to increase the internal temperature, otherwise damage to the devices may occur.</p>
Humidity	<p>RH≤90%</p> <p>Prevent condensation.</p> <p>The maximum relative humidity should be equal to or less than 60% in corrosive air.</p>
Storage temperature	-40 °C~+70°C, and the temperature changing rate is less than 1°C/minute.
Running environment condition	<p>The installation site of the inverter should be kept away from ant electromagnetic radiation source;</p> <p>kept away from contaminative air, such as corrosive gas, oil mist and flammable gas;</p>

Environment	Conditions
	Ensure foreign objects, such as metal, dust, oil, water can not enter into the inverter (do not install the inverter on flammable materials such as wood); Keep out of direct sunlight, oil mist, steam and vibration.
Altitude	Below 1000m If the sea level is above 1000m, please derate 1% for every additional 100m.
Vibration	$\leq 5.8\text{m/s}^2(0.6\text{g})$
Installation direction	The inverter should be installed on an upright position to ensure sufficient cooling effect.

Note:

- ◆ IMO XKL series inverters should be installed in a clean and well ventilated environment according to enclosure classification.
- ◆ Cooling air must be clean, free from corrosive materials and electrically conductive dust.

3.1.2 Installation direction

The inverter may be installed on the wall or in a cabinet.

The inverter must be installed in an upright position. Check the installation site according to the requirements below. Refer to chapter *Dimension Drawings* in the appendix for frame details.

3.1.3 Installation manner

The inverter can be installed in wall mounting (for all frame sizes):

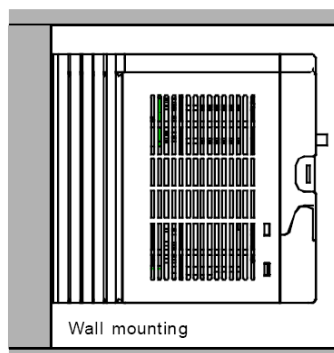

Fig 3-1 Installation mounting

- (1) Mark the hole location. The location of the holes is shown in the dimension drawings in the appendix.
- (2) Fix screws or bolts to the marked locations.
- (3) Position the drive onto backplate.
- (4) Tighten the screws in the backplate securely.

3.1.4 Installation space

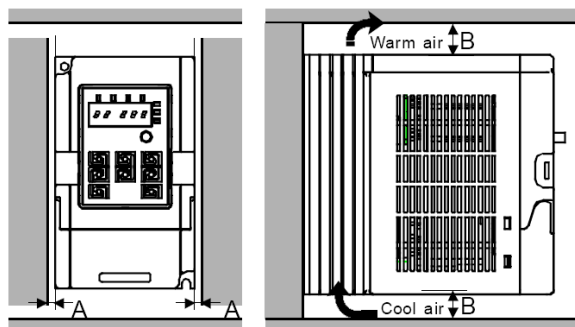

Fig 3-2 Installation space

Note: Fan cooled drives can be mounted side by side, natural cooled drives require 30mm clearance (Dim A) A minimum clearance of 100mm is required above and below the drive (Dim B).

3.2 Standard wiring

3.2.1 Connection diagram of main circuit

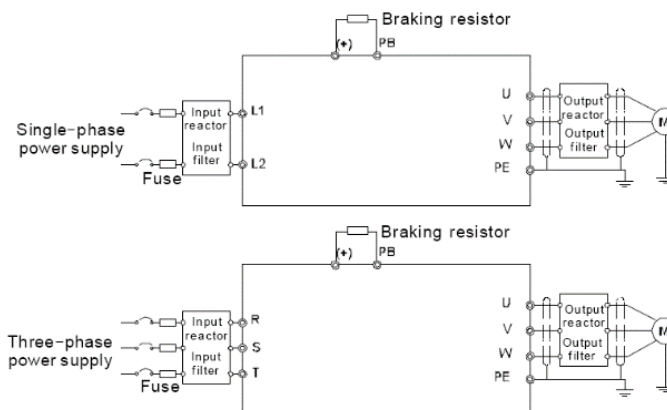

Diagram 3-3 Connection diagram of main circuit

Note:

- ◆ The fuse, DC reactor, braking resistor, input reactor, input filter, output reactor, output filter are optional parts. Please refer to **Peripheral Optional Parts** for detailed information.

3.2.2 Terminals figure of main circuit

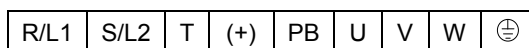

Fig 3-4 Terminals of main circuit

Terminal sign	Terminal name	Function
L1/R	Power input of the main circuit	3-phase/1-phase AC input terminals are generally connected to the incoming supply.
L2/S		
T		
U	The inverter output	3-phase AC output terminals are generally connected to the motor.
V		
W		
PB	Braking resistor terminal	PB and (+) are connected to an external resistor.

Terminal sign	Terminal name	Function
(+)		
⊖	Grounding terminal	Each machine has a standard PE terminal.

Note:

- ◆ Do not use an asymmetrically constructed motor cable. If there is a symmetrically constructed grounding conductor in the motor cable in addition to the conductive shield, connect the grounding conductor to the grounding terminal at the inverter and motor ends.
- ◆ Route the motor cable, input power cable and control cables separately.
- ◆ Terminal “T” is not used with single-phase input inverters.

3.2.3 Wiring of terminals in main circuit

1. Connect the grounding conductor of the input power cable with the grounding terminal of the inverter (**PE**) by **360** degree grounding technique. Connect the incoming supply to **R/L1**, **S/L2** and **T** terminals and fasten.
2. Strip the motor cable and connect the shield to the grounding terminal of the inverter by **360** degree grounding technique. Connect the motor to **U**, **V** and **W** terminals on drive and fasten.
3. Connect the optional brake resistor with a shielded cable to the designated position by the same procedures in the previous step.
4. Secure the cables outside the inverter mechanically.

3.2.4 Connection diagram of the control circuit

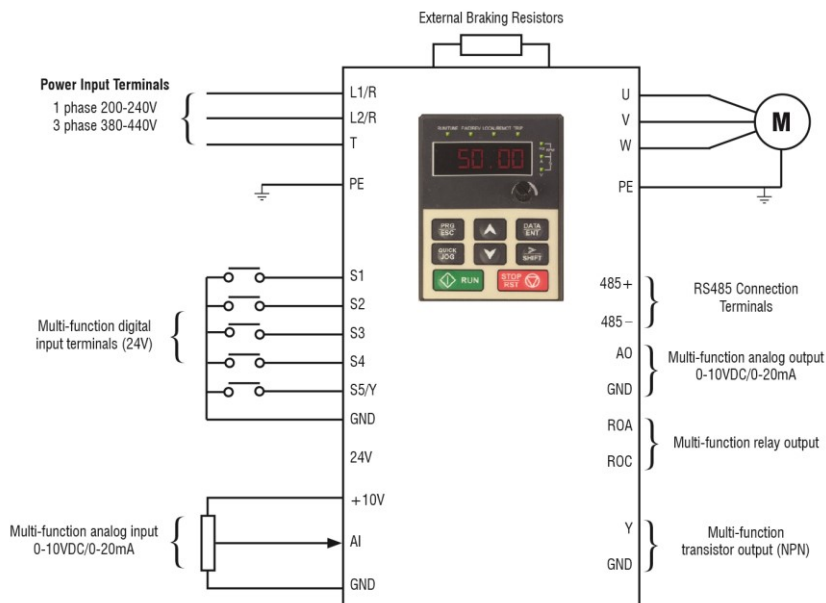

Figure 3-5 Connection diagram of the control circuit.

3.2.5 Wiring diagram of control circuit

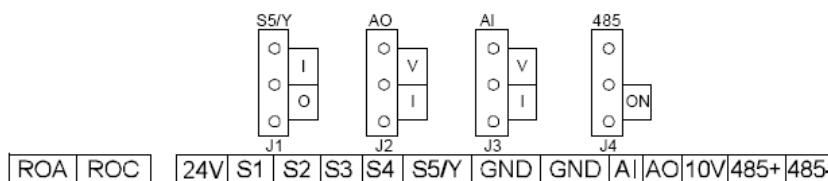

Fig 3-6 Wiring of control circuit

Description		
ROA	Output relay N/O terminal	(Relay contact rating: 3A/AC250V,1A/DC30V)
ROC	Output relay common terminal	
+10V	Local power supply +10Vdc for analog inputs.	
AI	1. Input range: AI voltage and current: 0~10V/0~20mA and switch by J3 2. Input impedance:voltage input: 20kΩ; current input: 500Ω 3. Resolution: the minimum is 5mV when 10V corresponds to 50Hz 4. Deviation ±1%, 25°C Note: Keypad potentiometer set by parameter AI1, external input set by parameter AI2.	
24V	Local +24V power supply, 100mA	
GND	+10V reference zero potential	
AO	1. Output range:0~10V or 0~20mA 2. The voltage/current is selected by jumper J2 3. Deviation±1%,25°C	
S1	Switch input 1	1. Internal impedance:3.3kΩ 2. 0~4V corresponds to low electric level input and 7~30V corresponds to high electric level input 3. Max input frequency:1kHz 4. All are programmable digital input terminal. User can set the terminal function through function codes.
S2	Switch input 2	
S3	Switch input 3	
S4	Switch input 4	
S5	Switch input 5	
Y	Digital output terminal	Note : S5 and Y can not be used at the same time
485+	485 communication interface and 485 differential signal interface	
485-	For standard 485 communication interface, please use twisted pairs or shield cable.	

3.3 Layout protection

3.3.1 Protect the inverter and input power cable in short-circuit situations

Protect the inverter and input power cable in short circuit situations and against thermal overload.

Arrange the protection according to the following guidelines.

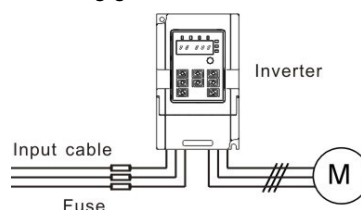



Fig 3-10 Fuse configuration

Note: Select the fuse specified in this manual. The fuse will protect the input power cable from short circuit. It will protect the surrounding devices in case of inverter internal short circuit.

3.3.2 Protecting the motor and motor cables

The inverter protects the motor and motor cable in a short-circuit situation when the motor cable is sized according to the rated current of the inverter. No additional protection devices are required.

	✧ If the inverter is connected to multiple motors, a separate thermal overload switch or a circuit breaker must be used for protecting each cable and motor. These devices may require a separate fuse for protection.
---	--

3.3.3 Implementing a bypass connection

It may be necessary to set power frequency and variable frequency conversion circuits for the assurance of continuous normal work of the inverter if faults.

In some special situations, for example, if it is only used in soft start, the inverter can be converted into power frequency running after starting and some corresponding bypass should be added.

	✧ Never connect the supply power to the inverter output terminals U, V and W. Power line voltage applied to the output can result in permanent damage to the inverter.
---	--

If frequent switching between units is required, use contactors with mechanical interlock to ensure that the motor terminals are not connected to the AC power line and inverter output terminals simultaneously.

4 Keypad Operation Procedure

The keypad is used to control *iDrive2* XKL series inverters, display active data and adjust parameters.

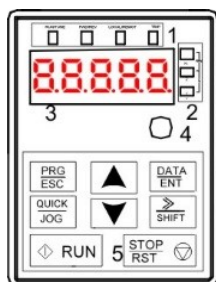









Fig 4-1 Keypad

Note: Fix the external keypad with M3 screws or the installation bracket. The installation bracket is optional.

Serial No.	Name	Description	
1	State LED	RUN/TUNE	LED off means that the inverter is in stopped state; LED flashing means the inverter is in parameter autotune state; LED on means the inverter is in running state.
		FWD/REV	FWD/REV LED LED off means the inverter is in forward rotation state; LED on means the inverter is in reverse rotation state
		LOCAL/REMOT	LED for keypad operation, terminals operation and remote communication control. LED off means that the inverter is in keypad control; LED flashing means the inverter is in terminal control; LED on means the inverter is in communication control.
		TRIP	LED for faults LED on when the inverter is in fault state; LED off in normal state; LED flashing means the inverter is in overload pre-alarm state.
2	Unit LED	Signifies the current unit type being displayed.	
		Hz	Frequency
		RPM	Rotating speed
		A	Current
		%	Percentage
V	Voltage		
3	Code displaying zone	5-digit LED display displays various monitoring data and alarm code such as set frequency and output frequency.	

Serial No.	Name	Description					
		Displayed word	Corresponding word	Displayed word	Corresponding word	Displayed word	Corresponding word
		0	0	1	1	2	2
		3	3	4	4	5	5
		6	6	7	7	8	8
		9	9	A	A	B	B
		C	C	d	d	E	E
		F	F	H	H	l	l
		L	L	N	N	n	n
		o	o	P	P	r	r
		S	S	t	t	U	U
		v	v	.	.	-	-
4	Digital potentiometer	Corresponds to AI1.					
5	Keys		Program key	Enter or escape from the first level menu and remove the parameter quickly			
			Entry key	Enter the menu step-by-step Confirm parameters			
			UP key	Increase data or function code progressively			
			DOWN key	Decrease data or function code progressively			
			Right-shift key	Move right to select the displaying parameter circularly in stopping and running mode. Select the parameter modifying digit during the parameter modification			
			Run key	This key is used to run the inverter in key operation mode			
			Stop/Reset key	This key is used to stop in running state and it is limited by function code P07.04 This key is used to reset all control modes in the fault alarm state			
			Quick key	The function of this key is confirmed by function code P07.02.			

4.1 Keypad display

The keypad display of IMO XKL series inverters is divided into stopped state parameter, running state parameter, function code parameter editing state and fault alarm state etc.

4.1.1 Display state of stopped parameter

When the inverter is in the stopped state, the keypad will display stop parameters which is shown in figure 4-2.

In the stopped state, various kinds of parameters can be displayed. Select the parameters to be displayed or not by P07.07. See the instructions of P07.07 for the detailed definition of each setting.

In the stopped state, there are 14 stopped parameters can be selected to be displayed or not. They are: set frequency, bus voltage, input terminals state, output terminals state, PID reference, PID feedback, AI1, AI2 and the current stage of multi-stage speeds, pulse counting value. P07.07 can select the parameter to be displayed or not by bit and **▶/SHIFT** can shift the parameters form left to right, **QUICK/JOG**(P07.02=2) can shift the parameters form right to left.

4.2.2 Display state of running parameters

After the inverter receives valid run commands, the inverter will enter into the run state and the keypad will display the running parameters. **RUN/TUNE** LED on the keypad is on, while the **FWD/REV** is determined by the current running direction which is shown as figure 4-2.

In the run state, there are 22 parameters can be selected to be displayed or not. They are: running frequency, set frequency, bus voltage, output voltage, output torque, PID reference, PID feedback, input terminals state, output terminals state, and the current stage of multi-stage speeds, pulse counting value, AI1, AI2, percentage of motor overload, percentage of inverter overload, linear speed. P07.05 and P07.06 can select the parameter to be displayed or not by bit and **▶/SHIFT** can shift the parameters form left to right, **QUICK/JOG**(P07.02=2) can shift the parameters from right to left.

4.1.3 Display state of fault

When the inverter detects a fault, it will enter into the fault pre-alarm display state. The keypad will display the fault code and the **TRIP** LED will flash. The trip can be reset by pressing **STOP/RST**

4.1.4 Displayed state of function codes editing

In stop state, running or fault, press **PRG/ESC** to enter into the editing state (if there is a password, see P07.00).The editing state is displayed on two classes of menu, and the order is: function code group/function code number→function code parameter, press **DATA/ENT** into the displayed state of function parameter. On this state, press **DATA/ENT** to save the parameters or press **PRG/ESC** to escape.

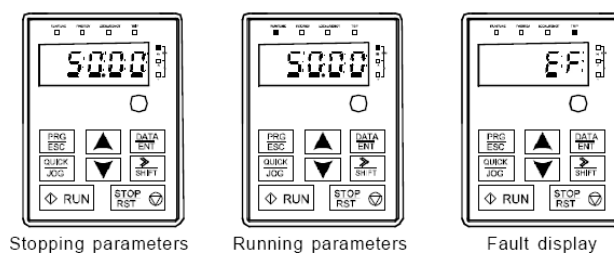

Fig 4-2 Displayed state

4.2 Keypad operation

Operate the inverter via keypad. See the detailed structure description of function codes in the brief diagram of function codes.

4.2.1 How to modify the function codes of the inverter

The inverter has three levels menu, which are:

1. Group number of function code (first-level menu)
2. Tab of function code (second-level menu)

3. Set value of function code (third-level menu)

Remarks: Press both the **PRG/ESC** and the **DATA/ENT** can return to the second-level menu from the third-level menu. The difference is: pressing **DATA/ENT** will save the set parameters into the control panel, and then return to the second-level menu with shifting to the next function code automatically; while pressing **PRG/ESC** will directly return to the second-level menu without saving the parameters, and keep staying at the current function code.

Under the third-level menu, if the parameter has no blinking bit, it means the function code cannot be modified. The possible reasons could be:

- 1) This function code is not modifiable parameter, such as actual detected parameter, operation records and so on;
- 2) This function code is not modifiable in running state, but modifiable in stop state.

Example: Set function code P00.01 from 0 to 1.

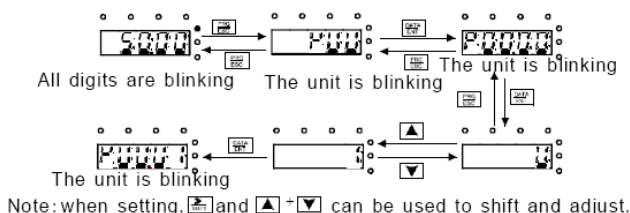

Fig 4-3 Flow diagram of modifying parameters

4.2.2 How to set the password of the inverter

IMO XKL series inverters provide password protection function for users. Use P7.00 to set a password, the password protection becomes valid instantly after quitting from the function code editing state. Press **PRG/ESC** again to the function code editing state, "0.0.0.0.0" will be displayed. Unless using the correct password, the operators cannot enter it.

Set P7.00 to 0 to cancel password protection function.

The password protection becomes valid instantly after retreating from the function code editing state. Press **PRG/ESC** again to the function code editing state, "0.0.0.0.0" will be displayed. Unless using the correct password, the operators cannot enter it.

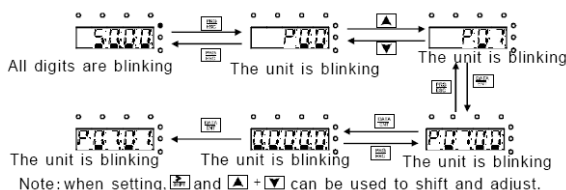

Fig 4-4 Flow diagram of password setting

4.2.3 How to monitor the inverter state through function codes

IMO XKL series inverters provide group P17 as the state inspection group. Users can enter into P17 directly to monitor the state.

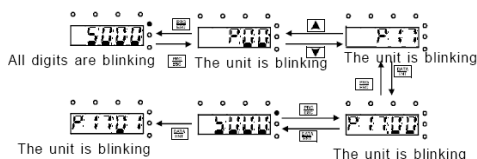

Fig 4-5 Flow diagram of state monitoring

5 Function Parameters

The function parameters of iDrive2 XKL series inverters have been divided into 30 groups (P00~P29) according to the function, of which P18~P28 are reserved. Each function group contains certain function codes applying 3-level menus. For example, "P08.08" means the eighth function code in the P8 group function, P29 group is factory reserved, and users are unable to access these parameters.

For simplicity of function codes setting, the function group number corresponds to the first level menu, the function code corresponds to the second level menu and the function code corresponds to the third level menu.

Parameter Menu.

Menu	Sub Menu	Description	Examples of Functions
P00	P00.00 – P00.18	Basic parameters	Run command type, Max frequency, ramp times
P01	P01.00 – P01.24	Start/Stop control	DC injection braking, coast to stop, delay start, auto restart
P02	P02.00 – P02.27	Motor 1 settings	Motor ratings, Kw, Current, speed
P04	P04.00 – P04.24	V/F control	Torque boost, slip compensation, V/F curve
P05	P05.00 – P05.41	Input terminals	Set function of digital inputs S1-S5
P06	P06.00 – P06.21	Output terminals	Set function of relay, transistor and analogue outputs
P07	P07.00 – P07.56	Keypad/HMI settings	Set user password, quick key function and display
P08	P08.00 – P08.50	Enhanced functions	Jogging, cooling fan and dynamic braking functions
P09	P09.00 – P09.13	PID control settings	PID, SV and feedback source settings
P10	P10.00 – P10.32	Pre-set speeds & PLC	Pre-set speed values & PLC selection
P11	P11.00 – P11.13	Protective functions	Set protective function trip/output levels
P14	P14.00 – P14.06	Comms settings	Baud rate, check bits and other Modbus/RS485 settings
P17	P17.00 – P17.37	Monitoring	Monitor live values of inverter during operation

1. Below is the instruction of the function lists:

The first column "Function code": code of function parameter group and parameters;

The second column "Name": full name of function parameters;

The third column "Detailed illustration of parameters": Detailed explanation of the function parameters

The fourth column "Default value": the original factory set value of the function parameter;

The fifth column "Modify": shows the modification ability of the parameter according to the list:-

"○": means the set value of the parameter can be modified in stop and running state;

"⊙": means the set value of the parameter can only be modified in stop state;

"●": means the value of the parameter is the real detection value which can not be modified.

Function code	Name	Detailed instruction of parameters	Default value	Modify
P00 Group Basic function group				
P00.00	Speed control mode	2:PWM control (suitable for AM) 2 is suitable in cases where it does not need high control accuracy, such as the load of fan and pump. One inverter can drive multiple motors.	2	⊙

Function code	Name	Detailed instruction of parameters	Default value	Modify
P00.01	Run command method	<p>Selects the run command method of the inverter.</p> <p>The control command of the inverter includes: start, stop, forward, reverse, jogging and fault reset.</p> <p>0:Keypad run command method (“LOCAL/REMOT” light off)</p> <p>Run command control by RUN, STOP/RST on the keypad.</p> <p>Set the multi-function key QUICK/JOG to FWD/REV shifting function (P07.02=3) to change the running direction; press RUN and STOP/RST simultaneously in running state to make the inverter coast to stop.</p> <p>1:Terminal run command method (“LOCAL/REMOT” flashing)</p> <p>Terminal run command control by the forward rotation, reverse rotation and forward jogging and reverse jogging of the multi-function terminals</p> <p>2:Communication run command method (“LOCAL/REMOT” on);</p> <p>The running command is controlled by via communication</p>	0	○
P00.03	Max. output frequency	<p>Sets the maximum output frequency of the drive.</p> <p>Acceleration and deceleration times are based on this setting.</p> <p>Setting range: P00.04~400.00Hz</p>	50.00Hz	◎
P00.04	Output frequency high limit	<p>Limits the maximum running frequency.</p> <p>Setting range:P00.05~P00.03 (Max. output frequency)</p>	50.00Hz	◎
P00.05	Output frequency low limit	<p>Limits the minimum running frequency.</p> <p>The inverter runs at the lower limit frequency even if the set frequency is lower than the low limit setting.</p> <p>Note: Max. Output frequency ≥ Frequency high limit ≥ Frequency low limit.</p> <p>Setting range:0Hz~P00.04 (Frequency high limit.).</p>	0.00Hz	◎
P00.06	A. frequency command selection	<p>0:Keypad data setting.</p> <p>Modify the value of function code P00.10 (set the frequency by keypad) to modify the frequency by the keypad.</p>	0	○
P00.07	B. frequency	<p>1:Analog AI1 setting</p>	2	○

Function code	Name	Detailed instruction of parameters	Default value	Modify
	command selection	<p>2:Analog AI2 setting</p> <p>Analog input terminal sets the frequency. There are 2 standard analog input terminal, of which AI1 is adjusted through digital potentiometer, AI2 (0~10V/0~20mA) this is set by the jumper.</p> <p>Note: when AI2 selects 0~20mA input, 20mA corresponds to 10V.</p> <p>100.0% of the analog input corresponds to P00.03, -100.0% of the analog input corresponds to the reverse P00.03.</p> <p>6: Multi-stage speed running setting</p> <p>The inverter runs at multi-stage speed mode when P00.06=6 or P00.07=6. Set P05 to select the current running stage, and set P10 to select the current running frequency.</p> <p>The multi-stage speed has the priority when P00.06 or P00.07 does not equal to 6, but the setting stage can only be the 1~15 stage. The setting stage is 1~15 if P00.06 or P00.07 equals to 6.</p> <p>7: PID control setting</p> <p>The running mode of the inverter is process PID control when P00.06=7 or P00.07=7. It is necessary to set P09. The running frequency of the inverter is the value after PID effect. See P09 for the detailed information of the preset source, preset value, feed-back source of PID.</p> <p>8:MODBUS communication setting</p> <p>The frequency is set by MODBUS communication. See P14 for detailed information.</p> <p>Note: A frequency and B frequency can not set as the same frequency reference method.</p>		
P00.08	B frequency command reference	<p>0: Maximum output frequency, 100% of B frequency setting corresponds to the maximum output frequency</p> <p>1: A frequency command, 100% of B frequency setting corresponds to the maximum output frequency. Select this setting if it needs to adjust on the base of A frequency command</p>	0	<input type="radio"/>
P00.09	Combination type of the	0: A, the current frequency setting is A frequency command	0	<input type="radio"/>

Function code	Name	Detailed instruction of parameters	Default value	Modify
	setting source	<p>1: B, the current frequency setting is B frequency command</p> <p>2: A+B, the current frequency setting is sum of A+B frequency command.</p> <p>3: A-B, the current frequency setting is A frequency command - B frequency command</p> <p>4: Max (A, B): The highest value of A and B is the set frequency.</p> <p>5: Min (A, B): The lowest value of A and B is the set frequency.</p> <p>Note:The combination manner can be shifted by P05(terminal function).</p>		
P00.10	Keypad set frequency	<p>When A and B frequency commands are selected as "keypad setting", this parameter will be the initial value of inverter reference frequency</p> <p>Setting range:0.00 Hz~P00.03(the Max. frequency)</p>	50.00Hz	<input type="radio"/>
P00.11	ACC time 1	Time (secs) to ramp up to Max frequency (P00.03) from 0Hz.	Depend on model	<input type="radio"/>
P00.12	DEC time 1	<p>Time (secs) to ramp down from Max frequency (P00.03) to 0Hz.</p> <p>IMO XKL series inverters define four groups of ACC/DEC time which can be selected by P05. The factory default ACC/DEC time of the inverter is the first group.</p> <p>Setting range of P00.11 and P00.12:0.0~3600.0s</p>	Depend on model	<input type="radio"/>
P00.13	Running direction selection	<p>0: Runs at the default direction, the inverter runs in the forward direction. FWD/REV indicator is off.</p> <p>1: Runs at the opposite direction, the inverter runs in the reverse direction. FWD/REV indicator is on.</p> <p>Modify the function code to shift the rotation direction of the motor. The motor rotation direction can be changed by QUICK/JOG on the keypad. Refer to parameter P07.02.</p> <p>Note: Factory reset returns motor direction to default, check direction of motor is correct before running after reset.</p> <p>2: Forward run only: Prevents motor running in reverse direction.</p>	0	<input type="radio"/>

Function code	Name	Detailed instruction of parameters	Default value	Modify																				
P00.14	Carrier frequency setting	<table border="1" style="margin-left: auto; margin-right: auto;"> <tr> <td>Carrier frequency</td> <td>RFI noise</td> <td>Earth leakage</td> <td>Heat generation</td> </tr> <tr> <td>1kHz</td> <td style="text-align: center;">▲ High</td> <td style="text-align: center;">▲ Low</td> <td style="text-align: center;">▲ Low</td> </tr> <tr> <td>4 kHz</td> <td></td> <td></td> <td></td> </tr> <tr> <td>8kHz</td> <td style="text-align: center;">▼ Low</td> <td style="text-align: center;">▼ High</td> <td style="text-align: center;">▼ High</td> </tr> </table> <p>The relationship table of the motor type and carrier frequency:</p> <table border="1" style="margin-left: auto; margin-right: auto;"> <thead> <tr> <th>Motor type</th> <th>The factory value of carrier frequency</th> </tr> </thead> <tbody> <tr> <td>0.2~2.2kW</td> <td style="text-align: center;">4kHz</td> </tr> </tbody> </table> <p>The advantage of high carrier frequency: ideal current waveform, little current harmonic wave and motor noise. The disadvantage of high carrier frequency: increasing the switch loss, increasing inverter temperature and the impact to the output capacity. The inverter needs to derate on high carrier frequency. At the same time, the leakage and electrical magnetic interference will increase. Applying low carrier frequency is contrary to the above, too low carrier frequency will cause unstable running, torque decreasing and surge. The default setting of 4KHz is suitable for most general applications and should not need to be changed. When the frequency used exceeds the default carrier frequency, the inverter needs to derate 20% for each additional 1k carrier frequency. Setting range:1.0~8.0kHz</p>	Carrier frequency	RFI noise	Earth leakage	Heat generation	1kHz	▲ High	▲ Low	▲ Low	4 kHz				8kHz	▼ Low	▼ High	▼ High	Motor type	The factory value of carrier frequency	0.2~2.2kW	4kHz	Depend on model	○
Carrier frequency	RFI noise	Earth leakage	Heat generation																					
1kHz	▲ High	▲ Low	▲ Low																					
4 kHz																								
8kHz	▼ Low	▼ High	▼ High																					
Motor type	The factory value of carrier frequency																							
0.2~2.2kW	4kHz																							
P00.16	AVR function selection	0:Invalid 1:Valid during the whole procedure. The auto-adjusting function of the inverter can cancel the impact on the output voltage of the inverter because of the bus voltage fluctuation.	1	○																				
P00.18	Function restore parameter	0:No operation 1:Restore the default value 2:Clear fault records Note: The function code will restore to 0 after finishing the operation of the selected function code.	0	◎																				

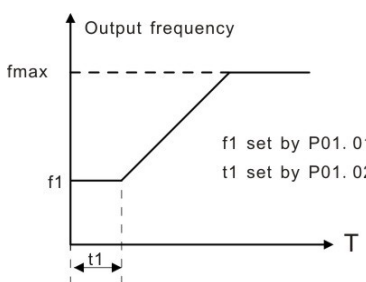
Function code	Name	Detailed instruction of parameters	Default value	Modify
		Restoring to the default value will cancel the user password, please use this function with caution.		
P01 Group Start-up and stop control				
P01.00	Start mode	0:Start-up directly:start from the starting frequency P01.01 1:Start-up after DC braking: start the motor from the starting frequency after DC braking (set the parameter P01.03 and P01.04). It is suitable in the cases where reverse rotation may occur to the low inertia load during starting.	0	⊙
P01.01	Starting frequency of direct start-up	Starting frequency of direct start-up means the original frequency during the inverter starting. See P01.02 for detailed information. Setting range: 0.00~50.00Hz	0.50Hz	⊙
P01.02	Retention time of the starting frequency	Set a proper starting frequency to increase the torque of the inverter during starting. During the retention time of the starting frequency, the output frequency of the inverter is the starting frequency. And then, the inverter will run from the starting frequency to the set frequency. If the set frequency is lower than the starting frequency, the inverter will stop running and keep in the stand-by state. The starting frequency is not limited in the lower limit frequency.  Setting range: 0.0~50.0s	0.0s	⊙
P01.03	The braking current before starting	The inverter will carry out DC braking at the braking current set before starting and it will speed up after the DC braking time. If the DC braking time is set to 0, the DC braking is invalid.	0.0%	⊙
P01.04	The braking time before	The stronger the braking current, the bigger the braking power. The DC braking current before starting means	0.00s	⊙

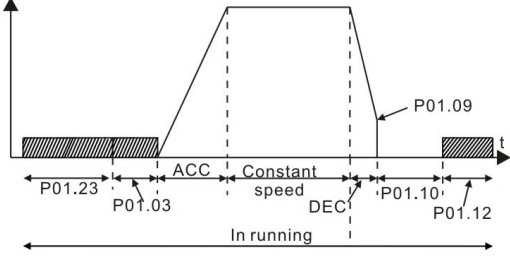
Function code	Name	Detailed instruction of parameters	Default value	Modify
	starting	the percentage of the rated current of the inverter. The setting range of P01.03: 0.0~100.0% The setting range of P01.04: 0.0~50.0s		
P01.05	ACC/DEC selection	The changing mode of the frequency during start-up and running. 0:Linear type The output frequency increases or decreases linearly.	0	⊙
P01.08	Stop selection	0: Decelerate to stop: after the stop command becomes valid, the inverter decelerates to decrease the output frequency during the set time. When the frequency decreases to 0, the inverter stops. 1: Coast to stop: after the stop command becomes valid, the inverter ceases the output immediately. And the load coasts to stop at the mechanical inertia.	0	○
P01.09	Starting frequency of DC braking	Starting frequency of DC braking: start the DC braking when running frequency reaches starting frequency determined by P1.09.	0.00Hz	○
P01.10	Waiting time before DC braking	Waiting time before DC braking: Inverters block the output before starting the DC braking. After this waiting time, the DC braking will be started so as to prevent over-current fault caused by DC braking at high speed.	0.00s	○
P01.11	DC braking current	DC braking current : The value of P01.11 is the percentage of rated current of inverter. The bigger the DC braking current is, the greater the braking torque is.	0.0%	○
P01.12	DC braking time	DC braking time: The retention time of DC brake. If the time is 0, the DC brake is invalid. The inverter will stop at the set deceleration time. 	0.00s	○
		The setting range of P01.09: 0.00Hz~P00.03 The setting range of P01.10: 0.0~50.0s The setting range of P01.11: 0.0~100.0% The setting range of P01.12: 0.0~50.0s		

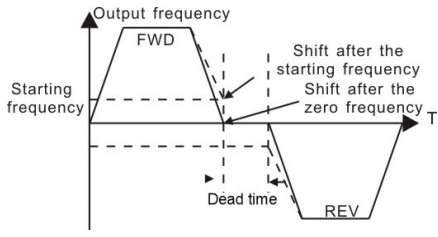
Function code	Name	Detailed instruction of parameters	Default value	Modify
P01.13	Dead time of FWD/REV rotation	<p>During the procedure of switching FWD/REV rotation, set the threshold by P01.14, which is as the table below:</p>  <p>Setting range: 0.0~3600.0s</p>	0.00s	○
P01.14	Switching between FWD/REV rotation	<p>Set the threshold point of the inverter:</p> <p>0:Switch after 0 frequency 1:Switch after the starting frequency 2:Switch after a delay time when the inverter stops</p>	0	◎
P01.15	Stopping speed	0.00~100.00Hz	1.00 Hz	◎
P01.18	Terminal Run protection when powering on	<p>When the run command is set to terminal control, the system will detect the state of the run terminal during powering on.</p> <p>0: The terminal run command is invalid when powering on. Even the running command is detected to be valid during powering on, the inverter won't run and the system keeps in the protection state until the running command is cancelled and re-enabled.</p> <p>1: The terminal run command is valid when powering on. If the run command is detected to be valid during powering on, the system will start the inverter automatically after the initialization.</p> <p>Note: this function should be selected with caution!!</p>	0	○
P01.19	The running frequency is lower than the lower limit one (valid if the lower limit frequency is above 0)	<p>This function code determines the running state of the inverter when the set frequency is lower than the lower-limit one.</p> <p>0: Run at the lower-limit frequency 1: Stop 2: Hibernation</p> <p>The inverter will coast to stop when the set frequency is lower than the lower-limit one.if the set frequency is above the lower limit one again and it lasts for the time set by P01.20, the inverter will return to the running state</p>	0	◎

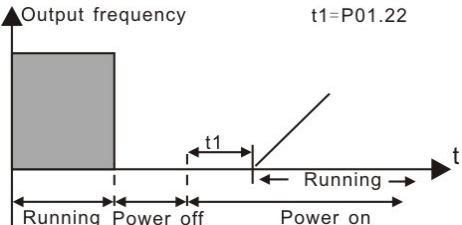
Function code	Name	Detailed instruction of parameters	Default value	Modify
		automatically.		
P01.20	Hibernation restore delay time	<p>Sets the hibernation delay time. When the running frequency of the inverter is lower than the lower limit one, the inverter will pause to stand by.</p> <p>When the set frequency is above the lower limit for longer than time set by P01.20, the inverter will run automatically.</p> <p>Note: The time is the total value when the set frequency is above the lower limit one.</p> <p>Setting range: 0.0~3600.0s (valid when P01.19=2)</p>	0.0s	○
P01.21	Restart after power off	<p>This function can enable the inverter start or not after the power off and then power on.</p> <p>0: Disabled</p> <p>1: Enabled, if the starting need is met, the inverter will run automatically after waiting for the time defined by P01.22.</p>	0	○
P01.22	Restart delay time after power off	<p>The function sets the delay time before the automatic running of the inverter after power up.</p>  <p>Setting range: 0.0~3600.0s (valid when P01.21=1)</p>	1.0s	○
P01.23	Start delay time	<p>The function determines the brake release after the running command is given, and the inverter is in a stand-by state and wait for the delay time set by P01.23</p> <p>Setting range: 0.0~60.0s</p>	0.0s	○
P01.24	Delay of the stopping speed	Setting range: 0.0~100.0 s	0.0s	○
P02 Group Motor 1				
P02.01	Asynchronous motor rated power	0.1~3000.0kW	Depend on model	◎

Function code	Name	Detailed instruction of parameters	Default value	Modify
P02.02	Asynchronous motor rated frequency	0.01Hz~P00.03 (the Max. frequency)	50.00Hz	☉
P02.03	Asynchronous motor rated speed	1~36000rpm	Depend on model	☉
P02.04	Asynchronous motor rated voltage	0~1200V	Depend on model	☉
P02.05	Asynchronous motor rated current	0.8~6000.0A	Depend on model	☉
P02.06	Asynchronous motor stator resistor	0.001~65.535Ω	Depend on model	○
P02.07	Asynchronous motor rotor resistor	0.001~65.535Ω	Depend on model	○
P02.08	Asynchronous motor leakage inductance	0.1~6553.5mH	Depend on model	○
P02.09	Asynchronous motor mutual inductance	0.1~6553.5mH	Depend on model	○
P02.10	Asynchronous motor non-load current	0.1~6553.5A	Depend on model	○
P02.26	Motor overload protection	0:No protection 1: Common motor (with low speed compensation). Because the heat-releasing effect of the common motors will be weakened, the corresponding electric heat	2	☉

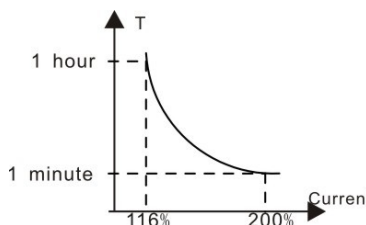
Function code	Name	Detailed instruction of parameters	Default value	Modify
		<p>protection will be adjusted properly. The low speed compensation characteristic mentioned here means reducing the threshold of the overload protection of the motor whose running frequency is below 30Hz.</p> <p>2: Frequency conversion motor (without low speed compensation) Because the heat-releasing effect of the specific motors won't be impacted by the rotation speed, it is not necessary to adjust the protection value during low-speed running.</p>		
P02.27	Motor overload protection coefficient	<p>When P02.27=overload protection current of the motor/rated current of the motor</p> <p>So, the bigger the overload coefficient is, the shorter the reporting time of the overload fault is. When the overload coefficient <110%, there is no overload protection. When the overload coefficient =116%, the fault will be reported after 1 hour, when the overload coefficient=200%, the fault will be reported after 1 minute.</p>  <p>Setting range: 20.0%~120.0%</p>	100.0%	<input type="radio"/>
P04 Group V/F control				
P04.00	Motor V/F curve setting	<p>DefineS the V/F curve of IMO XKL motor to meet the need of different loads.</p> <p>0: Straight line V/F curve; applying to the constant torque load</p> <p>1: Multi-dots V/F curve</p>	0	<input checked="" type="radio"/>
P04.01	Torque boost	Torque boost to the output voltage for the features of low frequency torque. P04.01 is for the Max. Output voltage V_b .	0.0%	<input type="radio"/>
P04.02	Torque boost close	<p>P04.02 defines the percentage of closing frequency of manual torque to f_b.</p> <p>Torque boost should be selected according to the load. The larger the load is, the higher the torque is. Too high torque boost will create excessive magnetizing current,</p>	20.0%	<input type="radio"/>

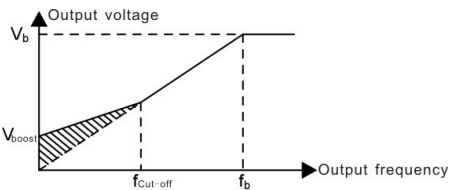
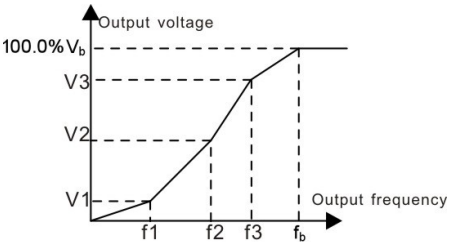
Function code	Name	Detailed instruction of parameters	Default value	Modify
		<p>and the current of the inverter will increase the temperature of the inverter and decrease the efficiency. When the torque boost is set to 0.0%, the inverter is automatic torque boost.</p> <p>Torque boost threshold: below this frequency point, the torque boost is valid, but over this frequency point, the torque boost is invalid.</p>  <p>The setting range of P04.01: 0.0%: (automatic) 0.1%~10.0% The setting range of P04.02:0.0%~50.0%</p>		
P04.03	Motor V/F frequency point 1	 <p>When P04.00 =1, the user can set V//F curve through P04.03~P04.08. V/F is generally set according to the load of the motor.</p> <p>Note: $V1 < V2 < V3, f1 < f2 < f3$. Too high or low frequency voltage can overheat the motor excessively or cause damage to the inverter.</p> <p>The setting range of P04.03: 0.00Hz~P04.05 The setting range of P04.04, P04.06 and P04.08 : 0.0%~110.0% The setting range of P04.05:P04.03~ P04.07 The setting range of P04.07:P04.05~P02.02 (the rated frequency of motor 1)</p>	0.00Hz	<input type="radio"/>
P04.04	Motor V/F voltage point 1		00.0%	<input type="radio"/>
P04.05	Motor V/F frequency point 2		00.00Hz	<input type="radio"/>
P04.06	Motor V/F voltage point 2		00.0%	<input type="radio"/>
P04.07	Motor V/F frequency point 3		00.00Hz	<input type="radio"/>
P04.08	Motor V/F voltage point 3		00.0%	<input type="radio"/>

Function code	Name	Detailed instruction of parameters	Default value	Modify
P04.09	Motor V/F slip compensation gain	<p>This function code is used to compensate the change of the rotation speed caused by load during running and improve the stability of the motor. It can be set to the rated slip frequency of the motor which is calculated as below:</p> $\Delta f = f_b - n \cdot p / 60$ <p>Of which, f_b is the rated frequency of the motor, its function code is P02.01; n is the rated rotating speed of the motor and its function code is P02.02; p is the pole pair of the motor. 100.0% corresponds to the rated slip frequency Δf.</p> <p>Note: no torque compensation for single-phase 220V inverters</p> <p>Setting range: 0.0~200.0%</p>	380V: 100.0%	○
			220V: 0%	
P04.10	Low frequency vibration control factor	In the V/F control mode, current fluctuation may occur to the motor on some frequency, especially larger kW motors.. The motor runs unstable or overcurrent may occur. This can be overcome by adjusting this parameter.	10	○
P04.11	High frequency vibration control factor	The setting range of P04.10: 0~100 The setting range of P04.11: 0~100	10	○
P04.12	Vibration control threshold	The setting range of P04.12: 0.00Hz~P00.03(the Max. frequency)	30.00 Hz	○
P04.26	Energy-saving operation	0: No operation 1: Automatic energy-saving The motor adjusts the output voltage in non-load state automatically.	0	◎
P05 Group Input terminals				
P05.01	S1 terminals function selection	0: No function 1: Forward rotation operation 2: Reverse rotation operation	1	◎
P05.02	S2 terminals function selection	3: 3-wire control operation 4: Forward rotation jogging 5: Reverse rotation jogging	4	◎

Function code	Name	Detailed instruction of parameters	Default value	Modify
P05.03	S3 terminals function selection	6: Coast to stop 7: Fault reset 8: Operation pause	7	⊙
P05.04	S4 terminals function selection	9: External fault input 10:Increasing frequency setting(UP) 11:Decreasing frequency setting(DOWN) 12:Cancel the frequency change setting	0	⊙
P05.05	S5 terminals function selection	13:Shift between A setting and B setting 14:Shift between combination setting and A setting 15:Shift between combination setting and B setting 16:Multi-stage speed terminal 1 17:Multi-stage speed terminal 2 18:Multi-stage speed terminal 3 19:Multi- stage speed terminal 4 20:Multi- stage speed pause 21:ACC/DEC time option 1 25:PID control pause 26:Traverse Pause(stop at the current frequency) 27:Traverse reset(return to the center frequency) 28:Counter reset 30:ACC/DEC prohibition 31:Counter trigger 33:Cancel the frequency change setting temporarily 34:DC brake 36:Shift the command to the keypad 37:Shift the command to the terminals 38:Shift the command to the communication	0	⊙

Function code	Name	Detailed instruction of parameters	Default value	Modify																																																																																																																																																																																																						
P05.10	Polarity selection of the input terminals	<p>The function code sets the polarity of the input terminals. Set Value according to normal/inverse switching requirements.</p> <p>Normal = <input type="checkbox"/> Inverse = <input type="checkbox"/></p> <table border="1" data-bbox="528 555 1128 1751"> <thead> <tr> <th>Value</th> <th>S5</th> <th>S4</th> <th>S3</th> <th>S2</th> <th>S1</th> </tr> </thead> <tbody> <tr><td>0</td><td></td><td></td><td></td><td></td><td></td></tr> <tr><td>1</td><td></td><td></td><td></td><td></td><td style="background-color: #cccccc;"></td></tr> <tr><td>2</td><td></td><td></td><td></td><td style="background-color: #cccccc;"></td><td></td></tr> <tr><td>3</td><td></td><td></td><td></td><td style="background-color: #cccccc;"></td><td style="background-color: #cccccc;"></td></tr> <tr><td>4</td><td></td><td></td><td style="background-color: #cccccc;"></td><td></td><td></td></tr> <tr><td>5</td><td></td><td></td><td style="background-color: #cccccc;"></td><td></td><td style="background-color: #cccccc;"></td></tr> <tr><td>6</td><td></td><td></td><td style="background-color: #cccccc;"></td><td style="background-color: #cccccc;"></td><td></td></tr> <tr><td>7</td><td></td><td></td><td style="background-color: #cccccc;"></td><td style="background-color: #cccccc;"></td><td style="background-color: #cccccc;"></td></tr> <tr><td>8</td><td></td><td style="background-color: #cccccc;"></td><td></td><td></td><td></td></tr> <tr><td>9</td><td></td><td style="background-color: #cccccc;"></td><td></td><td></td><td style="background-color: #cccccc;"></td></tr> <tr><td>A</td><td></td><td style="background-color: #cccccc;"></td><td></td><td style="background-color: #cccccc;"></td><td></td></tr> <tr><td>B</td><td></td><td style="background-color: #cccccc;"></td><td></td><td style="background-color: #cccccc;"></td><td style="background-color: #cccccc;"></td></tr> <tr><td>C</td><td></td><td style="background-color: #cccccc;"></td><td style="background-color: #cccccc;"></td><td></td><td></td></tr> <tr><td>D</td><td></td><td style="background-color: #cccccc;"></td><td style="background-color: #cccccc;"></td><td></td><td style="background-color: #cccccc;"></td></tr> <tr><td>E</td><td></td><td style="background-color: #cccccc;"></td><td style="background-color: #cccccc;"></td><td style="background-color: #cccccc;"></td><td></td></tr> <tr><td>F</td><td></td><td style="background-color: #cccccc;"></td><td style="background-color: #cccccc;"></td><td style="background-color: #cccccc;"></td><td style="background-color: #cccccc;"></td></tr> <tr><td>10</td><td style="background-color: #cccccc;"></td><td></td><td></td><td></td><td></td></tr> <tr><td>11</td><td style="background-color: #cccccc;"></td><td></td><td></td><td></td><td style="background-color: #cccccc;"></td></tr> <tr><td>12</td><td style="background-color: #cccccc;"></td><td></td><td></td><td style="background-color: #cccccc;"></td><td></td></tr> <tr><td>13</td><td style="background-color: #cccccc;"></td><td></td><td></td><td style="background-color: #cccccc;"></td><td style="background-color: #cccccc;"></td></tr> <tr><td>14</td><td style="background-color: #cccccc;"></td><td></td><td style="background-color: #cccccc;"></td><td></td><td></td></tr> <tr><td>15</td><td style="background-color: #cccccc;"></td><td></td><td style="background-color: #cccccc;"></td><td></td><td style="background-color: #cccccc;"></td></tr> <tr><td>16</td><td style="background-color: #cccccc;"></td><td></td><td style="background-color: #cccccc;"></td><td style="background-color: #cccccc;"></td><td></td></tr> <tr><td>17</td><td style="background-color: #cccccc;"></td><td></td><td style="background-color: #cccccc;"></td><td style="background-color: #cccccc;"></td><td style="background-color: #cccccc;"></td></tr> <tr><td>18</td><td style="background-color: #cccccc;"></td><td style="background-color: #cccccc;"></td><td></td><td></td><td></td></tr> <tr><td>19</td><td style="background-color: #cccccc;"></td><td></td><td></td><td></td><td style="background-color: #cccccc;"></td></tr> <tr><td>1A</td><td style="background-color: #cccccc;"></td><td></td><td></td><td style="background-color: #cccccc;"></td><td></td></tr> <tr><td>1B</td><td style="background-color: #cccccc;"></td><td style="background-color: #cccccc;"></td><td></td><td style="background-color: #cccccc;"></td><td style="background-color: #cccccc;"></td></tr> <tr><td>1C</td><td style="background-color: #cccccc;"></td><td style="background-color: #cccccc;"></td><td style="background-color: #cccccc;"></td><td></td><td></td></tr> <tr><td>1D</td><td style="background-color: #cccccc;"></td><td style="background-color: #cccccc;"></td><td style="background-color: #cccccc;"></td><td></td><td style="background-color: #cccccc;"></td></tr> <tr><td>1E</td><td style="background-color: #cccccc;"></td><td style="background-color: #cccccc;"></td><td style="background-color: #cccccc;"></td><td style="background-color: #cccccc;"></td><td></td></tr> <tr><td>1F</td><td style="background-color: #cccccc;"></td><td style="background-color: #cccccc;"></td><td style="background-color: #cccccc;"></td><td style="background-color: #cccccc;"></td><td style="background-color: #cccccc;"></td></tr> </tbody> </table>	Value	S5	S4	S3	S2	S1	0						1						2						3						4						5						6						7						8						9						A						B						C						D						E						F						10						11						12						13						14						15						16						17						18						19						1A						1B						1C						1D						1E						1F						0x000	○
Value	S5	S4	S3	S2	S1																																																																																																																																																																																																					
0																																																																																																																																																																																																										
1																																																																																																																																																																																																										
2																																																																																																																																																																																																										
3																																																																																																																																																																																																										
4																																																																																																																																																																																																										
5																																																																																																																																																																																																										
6																																																																																																																																																																																																										
7																																																																																																																																																																																																										
8																																																																																																																																																																																																										
9																																																																																																																																																																																																										
A																																																																																																																																																																																																										
B																																																																																																																																																																																																										
C																																																																																																																																																																																																										
D																																																																																																																																																																																																										
E																																																																																																																																																																																																										
F																																																																																																																																																																																																										
10																																																																																																																																																																																																										
11																																																																																																																																																																																																										
12																																																																																																																																																																																																										
13																																																																																																																																																																																																										
14																																																																																																																																																																																																										
15																																																																																																																																																																																																										
16																																																																																																																																																																																																										
17																																																																																																																																																																																																										
18																																																																																																																																																																																																										
19																																																																																																																																																																																																										
1A																																																																																																																																																																																																										
1B																																																																																																																																																																																																										
1C																																																																																																																																																																																																										
1D																																																																																																																																																																																																										
1E																																																																																																																																																																																																										
1F																																																																																																																																																																																																										
P05.11	Switch filter time	<p>Set the sample filter time of S1~S5 and HDI terminals. If the interference is strong, increase the parameter to avoid the disoperation.</p> <p>0.000~1.000s</p>	0.010s	○																																																																																																																																																																																																						

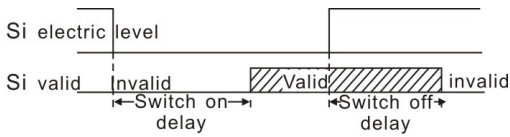
Function code	Name	Detailed instruction of parameters	Default value	Modify
P05.12	Virtual terminals setting	Enable the input function of virtual terminals at the communication mode. 0:Virtual terminals is invalid 1:MODBUS communication virtual terminals are valid	0	⊙
P05.13	Terminals control running mode	Set the operation mode of the terminals control 0:2-wire control 1, comply the enable with the direction. This mode is widely used. It determines the rotation direction by the defined FWD and REV terminals command. 1:2-wire control 2: Separate the enable from the direction. FWD defined by this mode is the enabling ones. The direction depends on the state of the defined REV. 2:3-wire control 1; Sin is the enabling terminal in this mode, and the running command is caused by FWD and the direction is controlled by REV. Sin is natural closed. 3:3-wire control 2; Sin is the enabling terminal on this mode, if set Si (i=1~5) to 3, when K is switched on, the control of FWD and REV is valid; when K is switched off, the control of FWD and REV is invalid. The inverter stops. Note: for the 2-wire running mode, when FWD/REV terminal is valid, the inverter stop because of the stopping command from other sources, even the control terminal FWD/REV keeps valid; the inverter won't work when the stopping command is canceled. Only when FWD/REV is relaunched, the inverter can start again.	0	⊙
P05.14	S1 terminal switching on delay time	The function code defines the corresponding delay time of electrical level of the programmable terminals from switching on to switching off.	0.000s	○
P05.15	S1 terminal switching off delay time		0.000s	○
P05.16	S2 terminal switching on delay time	Setting range:0.000~50.000s	0.000s	○

Function code	Name	Detailed instruction of parameters	Default value	Modify
P05.17	S2 terminal switching off delay time		0.000s	<input type="radio"/>
P05.18	S3 terminal switching on delay time		0.000s	<input type="radio"/>
P05.19	S3 terminal switching off delay time		0.000s	<input type="radio"/>
P05.20	S4 terminal switching on delay time		0.000s	<input type="radio"/>
P05.21	S4 terminal switching off delay time		0.000s	<input type="radio"/>
P05.22	S5 terminal switching on delay time		0.000s	<input type="radio"/>
P05.23	S5 terminal switching off delay time		0.000s	<input type="radio"/>
P05.32	Lower limit of AI1		<p>The function code defines the relationship between the analog input voltage and its corresponding set value. If the analog input voltage beyond the set minimum or maximum input value, the inverter will count at the minimum or maximum one.</p> <p>When the analog input is the current input, the corresponding voltage of 0~20mA is 0~10V.</p> <p>In different cases, the corresponding rated value of 100.0% is different. See the application for detailed information.</p> <p>The figure below illustrates different applications:</p>	0.00V
P05.33	Corresponding setting of the lower limit of AI1	0.0%		<input type="radio"/>
P05.34	Upper limit of AI1	10.00V		<input type="radio"/>
P05.35	Corresponding setting of the upper	100.0%		<input type="radio"/>

Function code	Name	Detailed instruction of parameters	Default value	Modify	
	limit of AI1				
P05.36	AI1 input filter time		0.100s	<input type="radio"/>	
P05.37	Lower limit of AI2		0.00V	<input type="radio"/>	
P05.38	Corresponding setting of the lower limit of AI2		Input filter time: this parameter is used to adjust the sensitivity of the analog input. Increasing the value properly can enhance the anti-interference of the analog, but weaken the sensitivity of the analog input. Note: AI2 can support 0~10V or 0~20mA input, when AI2 selects 0~20mA input, the corresponding voltage of 20mA is 5V. AI3 can support the output of -10V~+10V.	0.0%	<input type="radio"/>
P05.39	Upper limit of AI2		10.00V	<input type="radio"/>	
P05.40	Corresponding setting of the upper limit of AI2		The setting range of P05.32:0.00V~P05.34 The setting range of P05.33:-100.0%~100.0% The setting range of P05.34:P05.32~10.00V The setting range of P05.35:-100.0%~100.0%	100.0%	<input type="radio"/>
P05.41	AI2 input filter time	The setting range of P05.36:0.000s~10.000s The setting range of P05.37:0.00V~P05.39 The setting range of P05.38:-100.0%~100.0% The setting range of P05.39:P05.37~10.00V The setting range of P05.40:-100.0%~100.0% The setting range of P05.41:0.000s~10.000s	0.100s	<input type="radio"/>	
P06 Group Output terminals					
P06.01	Y1 output selection	0:Invalid 1:On operation	0	<input type="radio"/>	
P06.03	Relay RO output	2:Forward rotation operation 3:Reverse rotation operation 4: Jogging operation 5:The inverter fault 6:Frequency detection FDT1 7:Frequency detection FDT2 8:Frequency arrival 9:Zero speed running 10:Upper limit frequency arrival 11:Lower limit frequency arrival	1	<input type="radio"/>	

Function code	Name	Detailed instruction of parameters	Default value	Modify															
		12:Ready for operation 14:Overload pre-alarm 15: Underload pre-alarm 16:Completion of simple PLC stage 17:Completion of simple PLC cycle 18:Setting count value arrival 19:Defined count value arrival 20:External fault valid 22:Running time arrival 23:MODBUS communication virtual terminals output																	
P06.05	Polarity of output terminals	Sets switching polarity of Relay and Transistor outputs. Set Value according to normal/inverse switching requirements. <table border="1" style="margin-left: 20px;"> <thead> <tr> <th>Value</th> <th>RO1</th> <th>Y</th> </tr> </thead> <tbody> <tr> <td>0</td> <td>Normal</td> <td>Normal</td> </tr> <tr> <td>1</td> <td>Normal</td> <td>Inverse</td> </tr> <tr> <td>4</td> <td>Inverse</td> <td>Normal</td> </tr> <tr> <td>5</td> <td>Inverse</td> <td>Inverse</td> </tr> </tbody> </table>	Value	RO1	Y	0	Normal	Normal	1	Normal	Inverse	4	Inverse	Normal	5	Inverse	Inverse	00	○
Value	RO1	Y																	
0	Normal	Normal																	
1	Normal	Inverse																	
4	Inverse	Normal																	
5	Inverse	Inverse																	
P06.06	Y1 switching on delay time	0.000~50.000s	0.000s	○															
P06.07	Y1 switching off delay time	0.000~50.000s	0.000s	○															
P06.10	RO switching on delay time	The function code defines the corresponding delay time of the electrical level change during the programmable terminal switching on and off.	0.000s	○															
P06.11	RO switching off delay time	<p>The setting range :0.000~50.000s</p>	0.000s	○															
P06.14	AO output	0:Running frequency 1:Set frequency 2:Ramp reference frequency 3:Running rotation speed 4:Output current (relative to the rated current of the inverter) 5:Output current (relative to the rated current of the	0	○															

Function code	Name	Detailed instruction of parameters	Default value	Modify
		motor) 6:Output voltage 7:Output power 8:Set torque value 9:Output torque 10:Analog AI1 input value 11:Analog AI2 input value 14:MODBUS communication set value 1 15:MODBUS communication set value 2		
P06.17	Lower limit of AO output	The above function codes define the relative relationship between the output value and analog output. When the output value exceeds the range of set maximum or minimum output, it will count according to the low-limit or upper-limit output.	0.0%	<input type="radio"/>
P06.18	Corresponding AO output to the lower limit		0.00V	<input type="radio"/>
P06.19	Upper limit of AO output		100.0%	<input type="radio"/>
P06.20	The corresponding AO output to the upper limit		When the analog output is current output, 1mA equals to 0.5V. In different cases, the corresponding analog output of 100% of the output value is different. Please refer to each application for detailed information.	10.00V
P06.21	AO output filter time	Setting range of P06.18 0.00V~10.00V Setting range of P06.19 P06.17~100.0% Setting range of P06.20 0.00V~10.00V Setting range of P06.21 0.000s~10.000s	0.000s	<input type="radio"/>
P07 Group Human-Machine Interface				
P07.00	User's password	0~65535 The password protection will be valid when setting any non-zero number. 00000: Clear the previous user's password, and make the password protection invalid. After the user's password becomes valid, if the password is incorrect, users cannot enter the parameter menu. Only correct password can make the user check or modify the parameters. Please remember all users'	0	<input type="radio"/>

Function code	Name	Detailed instruction of parameters	Default value	Modify
		<p>passwords.</p> <p>Retreat editing state of the function codes and the password protection will become valid in 1 minute. If the password is available, press PRG/ESC to enter into the editing state of the function codes, and then "0.0.0.0.0" will be displayed. Unless input right password, the operator can not enter into it.</p> <p>Note: restoring to the default value can clear the password, please use it with caution.</p>		
P07.02	QUICK/JOG function	<p>0: No function</p> <p>1: Jogging running. Press QUICK/JOG to operate the jogging running.</p> <p>2: Shift the display state by the shifting key. Press QUICK/JOG to shift the displayed function code from right to left.</p> <p>3: Shift between forward rotation and reverse rotation. Press QUICK/JOG to shift the direction of the frequency command. This function is only valid in the keypad commands.</p> <p>4: Clear UP/DOWN settings. Press QUICK/JOG to clear the set value of UP/DOWN.</p> <p>5: Coast to stop. Press QUICK/JOG to coast to stop.</p> <p>6: Shift the run command source. Press QUICK/JOG to shift the run command source.</p> <p>7: Quick commission mode(committee according to the non-factory parameter)</p> <p>Note: Press QUICK/JOG to shift between forward rotation and reverse rotation, the inverter does not record the state after shifting during powering off. The inverter will run according to parameter P00.13 during next power cycle.</p>	1	◎
P07.03	QUICK/JOG the shifting sequence selection of run command	<p>When P07.02=6, set the shifting sequence of run command channels.</p> <p>0: Keypad control → terminals control → communication control</p> <p>1: Keypad control ← → terminal control</p> <p>2: Keypad control ← → communication control</p> <p>3: Terminals control ← → communication control</p>	0	○

Function code	Name	Detailed instruction of parameters	Default value	Modify
P07.04	<u>STOP/RST</u> stop function	Select the stop function by <u>STOP/RST</u> . <u>STOP/RST</u> is valid in any state for the fault reset. 0:Only valid for the panel control 1:Valid for both panel and terminals control 2:Valid for both panel and communication control 3:Valid for all control modes	0	○
P07.05	The parameter selection1 of running state	0x0000~0xFFFF BIT0:running frequency (Hz on) BIT1:set frequency(Hz flickering) BIT2:bus voltage (Hz on) BIT3:output voltage(V on) BIT4:output current(A on) BIT5:running rotation speed (rpm on) BIT6:output power(% on) BIT7:output torque(% on) BIT8:PID reference(% flickering) BIT9:PID feedback value(% on) BIT10:input terminals state BIT11:output terminals state BIT12:torque set value(% on) BIT13:pulse counter value BIT14:length value BIT15:current stage in multi-stage speed	0x03FF	○
P07.06	The parameter selection 2 of running state	0x0000~0xFFFF BIT0: analog AI1 value (V on) BIT1: analog AI2 value (V on) BIT4: motor overload percentage (% on) BIT5: the inverter overload percentage (% on) BIT6: ramp frequency reference value(Hz on) BIT7: linear speed	0x0000	
P07.07	The parameter selection of the stop state	0x0000~0xFFFF BIT0:set frequency(Hz on, frequency flickering slowly) BIT1:bus voltage (V on) BIT2:input terminals state BIT3:output terminals state BIT4:PID reference (% flickering) BIT5:PID feedback value(% on) BIT7:analog AI1 value(V on)	0x00FF	○

Function code	Name	Detailed instruction of parameters	Default value	Modify
		BIT8:analog AI2 value(V on) BIT11:current stage in multi-stage speed BIT12:pulse counters		
P07.08	Frequency display coefficient	0.01~10.00 Displayed frequency=run frequency* P07.08	1.00	○
P07.09	Rotation speed coefficient	0.1~999.9% Mechanical rotation speed =120*displayed run frequency*P07.09/motor pole pairs	100.0%	○
P07.10	Linear speed displayed coefficient	0.1~999.9% Linear speed= Mechanical rotation speed*P07.10	1.0%	○
P07.11	Reserved			●
P07.12	Module temperature	-20.0~120.0°C		●
P07.13	Software version	1.00~655.35		●
P07.14	Local accumulative running time	0~65535h		●
P07.18	The rated power of the inverter	0.4~3000.0kW		●
P07.19	The rated voltage of the inverter	50~1200V		●
P07.20	The rated current of the inverter	0.1~6000.0A		●
P07.21	Factory bar code 1	0x0000~0xFFFF		●
P07.22	Factory bar code 2	0x0000~0xFFFF		●
P07.23	Factory bar	0x0000~0xFFFF		●

Function code	Name	Detailed instruction of parameters	Default value	Modify
	code 3			
P07.24	Factory bar code 4	0x0000~0xFFFF		●
P07.25	Factory bar code 5	0x0000~0xFFFF		●
P07.26	Factory bar code 6	0x0000~0xFFFF		●
P07.27	Current fault type	0:No fault 4:OC1		●
P07.28	Previous fault type	5:OC2 6:OC3 7:OV1		●
P07.29	Previous 2 fault type	8:OV2 9:OV3		●
P07.30	Previous 3 fault type	10:UV 11:Motor overload (OL1)		●
P07.31	Previous 4 fault type	12:The inverter overload (OL2) 15:Overheat of the rectifier module (OH1) 16:Overheat fault of the inverter module (OH2)		●
P07.32	Previous 5 fault type	17:External fault (EF) 18:485 communication fault (CE) 21:EEPROM operation fault (EEP) 22:PID response offline fault (PIDE) 24:Run time arrival (END) 25:Electrical overload (OL3) 36: Undervoltage fault (LL)		●
P07.33	Current fault running frequency		0.00Hz	●
P07.34	Ramp reference frequency at current fault		0.00Hz	●
P07.35	Output voltage at current fault		0V	●

Function code	Name	Detailed instruction of parameters	Default value	Modify
P07.36	Output current at current fault		0.0A	●
P07.37	Bus voltage at current fault		0.0V	●
P07.38	The Max. temperature at current fault		0.0°C	●
P07.39	Input terminal state at current fault		0	●
P07.40	Output terminal state at current fault		0	●
P07.41	Previous fault running frequency		0.00Hz	●
P07.42	Ramp reference frequency at previous fault		0.00Hz	●
P07.43	Output voltage at the previous fault		0V	●
P07.44	The output current at the previous fault		0.0A	●
P07.45	Bus voltage at the previous fault		0.0V	●
P07.46	The Max.		0.0°C	●

Function code	Name	Detailed instruction of parameters	Default value	Modify
	temperature at the previous fault			
P07.47	Input terminals state at the previous fault		0	●
P07.48	Output terminals state at the previous fault		0	●
P07.49	Previous 2 fault running frequency		0.00Hz	●
P07.50	Output voltage at the previous 2 faults		0.00Hz	●
P07.51	Output current at the previous 2 faults		0V	●
P07.52	Output current at the previous 2 fault		0.0A	●
P07.53	Bus voltage at the previous 2 fault		0.0V	●
P07.54	The Max. temperature at previous 2 fault		0.0°C	●
P07.55	Input		0	●

Function code	Name	Detailed instruction of parameters	Default value	Modify
	terminals state at previous 2 fault			
P07.56	Output terminals state at previous 2 fault		0	●
P08 Group Enhanced function				
P08.00	ACC time 2	Refer to P00.11 and P00.12 for detailed definition. IMO XKL series selects four groups of ACC/DEC time which can be selected by P5 group. The first group of ACC/DEC time is the factory default. Setting range:0.0~3600.0s	Depend on model	○
P08.01	DEC time 2		Depend on model	○
P08.06	Jogging running frequency	This parameter is used to define the reference frequency during jogging. Setting range: 0.00Hz ~P00.03(the Max. frequency)	5.00Hz	○
P08.07	Jogging running ACC time	The jogging ACC time is the time to accelerate from 0Hz to the Max. Frequency.	Depend on model	○
P08.08	Jogging running DEC time	The jogging DEC time is the time to decelerate from the Max. Frequency (P0.03) to 0Hz. Setting range:0.0~3600.0s	Depend on model	○
P08.15	Traverse range	This function applies to the applications where traverse and convolution function are required such as textile and chemical fibre. The traverse function means that the output frequency of the inverter is fluctuated with the set frequency as its center. The route of the running frequency is illustrated as below, of which the traverse is set by P08.15 and when P08.15 is set as 0, the traverse is 0 with no function.	0.0%	○
P08.16	Sudden jumping frequency range		0.0%	○
P08.17	Traverse boost time		5.0s	○
P08.18	Traverse declining time		5.0s	○

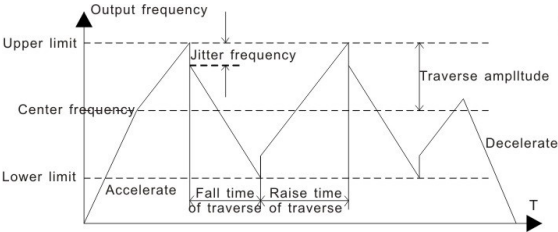
Function code	Name	Detailed instruction of parameters	Default value	Modify
		 <p>Traverse range: The traverse running is limited by upper and low frequency.</p> <p>The traverse range relative to the center frequency: traverse range $AW = \text{center frequency} \times \text{traverse range}$ P08.15.</p> <p>Sudden jumping frequency = traverse range $AW \times \text{sudden jumping frequency range}$ P08.16. When run at the traverse frequency, the value which is relative to the sudden jumping frequency.</p> <p>The raising time of the traverse frequency: The time from the lowest point to the highest one.</p> <p>The declining time of the traverse frequency: The time from the highest point to the lowest one.</p> <p>The setting range of P08.15: 0.0~100.0%(relative to the set frequency)</p> <p>The setting range of P08.16: 0.0~50.0%(relative to the traverse range)</p> <p>The setting range of P08.17: 0.1~3600.0s</p> <p>The setting range of P08.18: 0.1~3600.0s</p>		
P08.25	Setting counter value	The counter works by the input pulse signals of the HDI terminals.	0	○
P08.26	Reference counting value	<p>When the counter achieves a fixed number, the multi-function output terminals will output the signal of “fixed counting number arrival” and the counter go on working; when the counter achieves a setting number, the multi-function output terminals will output the signal of “setting counting number arrival”, the counter will clear all numbers and stop to recount before the next pulse.</p> <p>The setting counting value P08.26 should be no more than the setting counting value P08.25.</p> <p>The function is illustrated as below:</p>	0	○

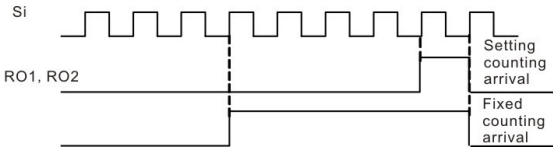
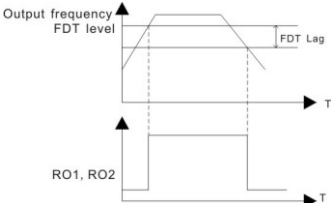
Function code	Name	Detailed instruction of parameters	Default value	Modify
		 <p>Setting range of P08.25:P08.26~65535 Setting range of P08.26:0~P08.25</p>		
P08.27	Setting running time	Pre-set running time of the inverter. When the accumulative running time reaches the set time, the multi-function digital output terminals will output the signal of “running time arrival”. Setting range:0~65535min	0m	○
P08.28	Time of fault reset	The time of the fault reset: The fault reset time can be set by this function. If the reset time exceeds this set value, the inverter will stop for the fault and wait to be repaired.	0	○
P08.29	Interval time of automatic fault reset	The interval time of the fault reset: The interval between the time when the fault occurs and the time when the reset action occurs. Setting range of P08.28:0~10 Setting range of P08.29:0.1~3600.0s	1.0s	○
P08.32	FDT electrical level detection value	When the output frequency exceeds the corresponding frequency of FDT level, the multi-function digital output terminals will output the signal of “frequency level detect FDT” until the output frequency decreases to a value lower than (FDT electrical level—FDT retention detection value) the corresponding frequency, the signal is invalid. Below is the waveform diagram:	50.00Hz	○
P08.33	FDT retention detection value	 <p>Setting range of P08.32: 0.00Hz~P00.03(the Max. frequency) Setting range of P08.33: 0.0~100.0%(FDT electrical level)</p>	5.0%	○
P08.36	Frequency arrival	When the output frequency is below or above the range of the set frequency, the multi-function digital output	0.00Hz	○

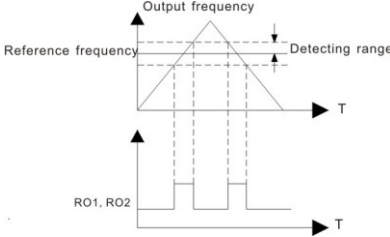
Function code	Name	Detailed instruction of parameters	Default value	Modify
	detection value	terminal will output the signal of “frequency arrival”, see the diagram below for detailed information:  The setting range:0.00Hz~P00.03(the Max. frequency)		
P08.37	Energy Braking enable	Used to control the internal braking resistor. 0:Disabled 1:Enabled Note: Only applied to internal braking resistor.	0	<input type="radio"/>
P08.38	Energy Braking threshold voltage	After setting the original bus voltage, adjust this parameter to brake the load appropriately. The factory value changes with voltage level. The setting range:200.0~2000.0V	220V voltage: 380.0V 380V voltage: 700.0V	<input type="radio"/>
P08.39	Cooling fan running mode	0: Thermal fan switching control. 1: Continuous running.	0	<input type="radio"/>
P08.40	PWM selection	0x0000~0x0021 LED ones: PWM mode selection 0: PWM mode 1, Three-phase modulation and two-phase modulation 1: PWM mode 2, Three-phase modulation LED tens: low-speed carrier frequency limit 0: low-speed carrier frequency limit mode 1; when the carrier frequency exceeds 1k at low speed, limit to 1k. 1: low-speed carrier frequency limit mode 2; when the carrier frequency exceeds 2k at low speed, limit to 2k. 2: No limit for the carrier frequency at low speed	0x01	<input checked="" type="radio"/>
P08.41	Over commission selection	0:Invalid 1:Valid	1	<input checked="" type="radio"/>

Function code	Name	Detailed instruction of parameters	Default value	Modify
P08.42	Keypad data control setting	0x000~0x1223 LED ones: frequency enable selection 0: \wedge/V keys adjustments are valid 1: Reserved 2: \wedge/V keys adjustments are invalid 3: Reserved LED tens: frequency control selection 0: Only valid when P00.06=0 or P00.07=0 1: Valid for all frequency setting manner 2: Invalid for multi-stage speed when multi-stage speed has the priority LED hundreds: action selection during stopping 0: Setting is valid 1: Valid during running, cleared after stopping 2: Valid during running, cleared after receiving the stop command LED thousands: \wedge/V keys and digital potentiometer Integral function 0: The Integral function is valid 1: The Integral function is invalid	0x0000	○
P08.44	UP/DOWN terminals control setting	0x00~0x221 LED ones: frequency control selection 0: UP/DOWN terminals setting valid 1: UP/DOWN terminals setting invalid LED tens: frequency control selection 0: Only valid when P00.06=0 or P00.07=0 1: All frequency means are valid 2: When the multi-stage are priority, it is invalid to the multi-stage LED hundreds: action selection when stop 0: Setting valid 1: Valid in the running, clear after stop 2: Valid in the running, clear after receiving the stop commands	0x000	○
P08.45	UP terminal frequency increasing integral ratio	0.01~50.00 Hz/s	0.50 Hz/s	○

Function code	Name	Detailed instruction of parameters	Default value	Modify
P08.46	DOWN terminal frequency integral ratio	0.01~50.00 Hz/s	0.50 Hz/s	<input type="radio"/>
P08.47	Action when the frequency setting is off	0x000~0x111 LED ones: The action selection when the digital adjusting the frequency is off. 0:Save when the power is off 1:Clear when the power is off LED tens:The action selection when MODBUS set frequency is off 0:Save when the power is off 1:Clear when the power is off LED tens:The action selection when the other frequency set frequency is off 0:Save when the power is off 1:Clear when the power is off	0x000	<input type="radio"/>
P08.50	Magnetic flux braking	This function code is used to enable magnetic flux. 0: Invalid. 100~150: the bigger the coefficient, the bigger the braking torque. This inverter can slow down the motor by increasing the magnetic flux. The energy generated by the motor during braking can be transformed into heat energy by increasing the magnetic flux. The inverter monitors the state of the motor continuously even during the magnetic flux period. So the magnetic flux can be used in the motor stop, as well as to change the rotation speed of the motor. Its other advantages are: Brake immediately after the stop command. It does not need to wait the magnetic flux weaken. The cooling is better. The current of the stator other than the rotor increases during magnetic flux braking, while the cooling of the stator is more valid than the rotor.	0	<input checked="" type="radio"/>

Function code	Name	Detailed instruction of parameters	Default value	Modify
P09 Group PID control				
P09.00	PID reference source selection	<p>When the frequency command selection (P00.06, P00.07) is 7, the running mode of the inverter is procedure PID control.</p> <p>The parameter determines the "set value" during the PID procures.</p> <p>0:Keypad digital reference(P09.01) 1:Analog channel AI1 reference 2:Analog channel AI2 reference 5:Multi-stage speed set 6:MODBUS communication set</p> <p>The setting target of procedure PID is a relative one, 100% of the setting equals to 100% of the response of the controlled system.</p> <p>The system is calculated according to the relative value (0~100.0%).</p> <p>Note: Multi-stage speed reference, it is realized by setting P10</p>	0	○
P09.01	Keypad PID preset	<p>When P09.00=0, set the parameter whose basic value is the feedback value of the system.</p> <p>The setting range:-100.0%~100.0%</p>	0.0%	○
P09.02	PID feedback source Selection	<p>Select the PID channel by the parameter.</p> <p>1:Analog channel AI2 feedback 4:MODBUS communication feedback</p> <p>Note: The reference channel and the feedback channel can not coincide, otherwise, PID can not control validly.</p>	1	○
P09.03	PID output feature selection	<p>0: PID output is positive: When the feedback signal exceeds the PID reference value, the output frequency of the inverter will decrease to balance the PID. For example, the strain PID control during wrapup</p> <p>1: PID output is negative: When the feedback signal is stronger than the PID reference value, the output frequency of the inverter will increase to balance the PID. For example, the strain PID control during wrapdown</p>	0	○
P09.04	Proportional gain (Kp)	The function is applied to the proportional gain P of PID input.	1.00	○

Function code	Name	Detailed instruction of parameters	Default value	Modify
		P determines the strength of the whole PID adjuster. The parameter of 100 means that when the offset of PID feedback and reference value is 100%, the adjusting range of PID adjuster is the Max. Frequency (ignoring integral function and differential function). The setting range:0.00~100.00		
P09.05	Interval time(Ti)	This parameter determines the speed of PID adjuster to carry out integral adjustment on the deviation of PID feedback and reference. When the deviation of PID feedback and reference is 100%, the integral adjuster works continuously after the time (ignoring the proportional effect and differential effect) to achieve the Max. Frequency (P00.03) or the Max. Voltage (P04.31). Shorter the integral time, stronger is the adjustment Setting range: 0.01~10.00s	0.10s	○
P09.06	Differential time(Td)	This parameter determines the strength of the change ratio when PID adjuster carries out integral adjustment on the deviation of PID feedback and reference. If the PID feedback changes 100% during the time, the adjustment of integral adjuster (ignoring the proportional effect and differential effect) is the Max. Frequency (P00.03). Longer the integral time, stronger is the adjusting. Setting range: 0.00~10.00s	0.00s	○
P09.07	Sampling cycle(T)	This parameter means the sampling cycle of the feedback. The modulator calculates in each sampling cycle. The longer the sapling cycle is, the slower the response is. Setting range: 0.00~100.00s	0.10s	○
P09.08	PID control deviation limit	As shown in the diagram below, PID adjuster stops to work during the deviation limit. Set the function properly to adjust the accuracy and stability of the system.	0.0%	○

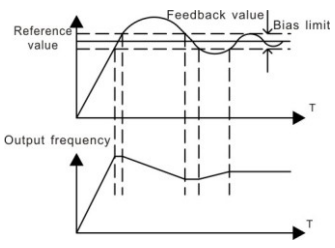
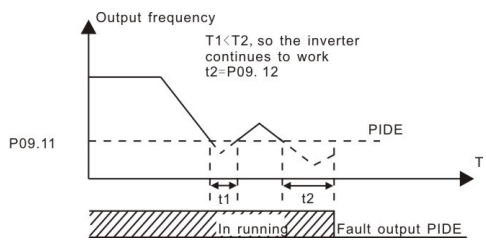
Function code	Name	Detailed instruction of parameters	Default value	Modify
		 <p>Setting range:0.0~100.0%</p>		
P09.09	Output upper limit of PID	These parameters are used to set the upper and lower limit of the PID adjustor output.	100.0%	<input type="radio"/>
P09.10	Output lower limit of PID	100.0 % corresponds to Max. Frequency Setting range of P09.09: P09.10~100.0% Setting range of P09.10: -100.0%~P09.09	0.0%	<input type="radio"/>
P09.11	Feedback offline detection value	Set the PID feedback offline detection value, when the detection value is smaller than or equal to the feedback offline detection value, and the lasting time exceeds the set value in P09.12, the inverter will report “PID feedback offline fault” and the keypad will display PIDE.	0.0%	<input type="radio"/>
P09.12	Feedback offline detection time	 <p>Setting range of P09.11: 0.0~100.0% Setting range of P09.12: 0.0~3600.0s</p>	1.0s	<input type="radio"/>
P09.13	PID adjustment selection	0x00~0x11 LED ones: 0: Keep on integral adjustment when the frequency achieves the upper and low limit; the integration shows the change between the reference and the feedback unless it reaches the internal integral limit. When the trend between the reference and the feedback changes, it needs more time to offset the impact of continuous working and the integration will change with the trend. 1: Stop integral adjustment when the frequency reaches the upper and low limit. If the integration keeps stable, and the trend between the reference and the feedback changes, the integration will change with the trend	0x00	<input type="radio"/>

Function code	Name	Detailed instruction of parameters	Default value	Modify
		quickly. LED tens: 0: The same with the setting direction; if the output of PID adjustment is different from the current running direction, the internal will output 0 forcedly. 1:Opposite to the setting direction		
P10 Group Simple PLC and multi-stage speed control				
P10.02	Multi-stage speed 0	100.0% of the frequency setting corresponds to the Max. Frequency P00.03.	0.0%	○
P10.04	Multi-stage speed 1	When selecting simple PLC running, set P10.02~P10.33 to define the running frequency and direction of all stages. Note: The symbol of multi-stage determines the running direction of simple PLC. The negative value means reverse rotation.	0.0%	○
P10.06	Multi-stage speed 2		0.0%	○
P10.08	Multi-stage speed 3		0.0%	○
P10.10	Multi-stage speed 4		0.0%	○
P10.12	Multi-stage speed 5		0.0%	○
P10.14	Multi-stage speed 6		0.0%	○
P10.16	Multi-stage speed 7		0.0%	○
P10.18	Multi-stage speed 8		0.0%	○
P10.20	Multi-stage speed 9		0.0%	○
P10.22	Multi-stage speed 10		0.0%	○
P10.24	Multi-stage speed 11	0.0%	○	
P10.26	Multi-stage speed 12	0.0%	○	

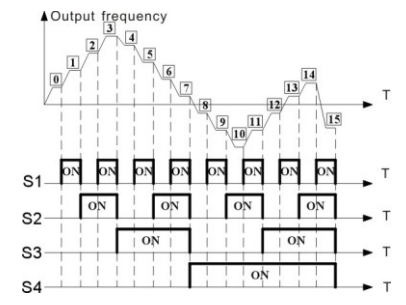
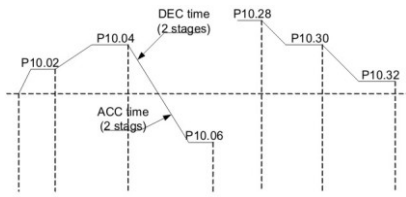

Multi-stage speeds are in the range of $-f_{max} \sim f_{max}$ and it can be IMO XKL series inverters can set 16 stages speed, selected by the combination of multi-stage terminals 1~4, corresponding to the speed 0 to speed 15.

When S1=S2=S3=S4=OFF, the frequency input reference is selected via P00.06 or P00.07. When all S1=S2=S3=S4 terminals aren't off, it runs at multi-stage which takes precedence of keypad, analog value, high-speed pulse, PLC, communication frequency input.

Function code	Name	Detailed instruction of parameters	Default value	Modify																																																																																										
P10.28	Multi-stage speed 13	Select at most 16 stages speed via the combination code of S1, S2, S3, and S4.	0.0%	<input type="radio"/>																																																																																										
P10.30	Multi-stage speed 14	The start-up and stopping of multi-stage running is determined by function code P00.06, the relationship between S1,S2,S3,S4 terminals and multi-stage speed is as following:	0.0%	<input type="radio"/>																																																																																										
P10.32	Multi-stage speed 15	<p>is as following:</p> <table border="1"> <tbody> <tr> <td>S1</td><td>OFF</td><td>ON</td><td>OFF</td><td>ON</td><td>OFF</td><td>ON</td><td>OFF</td><td>ON</td> </tr> <tr> <td>S2</td><td>OFF</td><td>OFF</td><td>ON</td><td>ON</td><td>OFF</td><td>OFF</td><td>ON</td><td>ON</td> </tr> <tr> <td>S3</td><td>OFF</td><td>OFF</td><td>OFF</td><td>OFF</td><td>ON</td><td>ON</td><td>ON</td><td>ON</td> </tr> <tr> <td>S4</td><td>OFF</td><td>OFF</td><td>OFF</td><td>OFF</td><td>OFF</td><td>OFF</td><td>OFF</td><td>OFF</td> </tr> <tr> <td>stage</td><td>0</td><td>1</td><td>2</td><td>3</td><td>4</td><td>5</td><td>6</td><td>7</td> </tr> <tr> <td>S1</td><td>OFF</td><td>ON</td><td>OFF</td><td>ON</td><td>OFF</td><td>ON</td><td>OFF</td><td>ON</td> </tr> <tr> <td>S2</td><td>OFF</td><td>OFF</td><td>ON</td><td>ON</td><td>OFF</td><td>OFF</td><td>ON</td><td>ON</td> </tr> <tr> <td>S3</td><td>OFF</td><td>OFF</td><td>OFF</td><td>OFF</td><td>ON</td><td>ON</td><td>ON</td><td>ON</td> </tr> <tr> <td>S4</td><td>ON</td><td>ON</td><td>ON</td><td>ON</td><td>ON</td><td>ON</td><td>ON</td><td>ON</td> </tr> <tr> <td>stage</td><td>8</td><td>9</td><td>10</td><td>11</td><td>12</td><td>13</td><td>14</td><td>15</td> </tr> </tbody> </table> <p>Setting range of P10.(2n,1<n<17): -100.0~100.0%</p>	S1	OFF	ON	OFF	ON	OFF	ON	OFF	ON	S2	OFF	OFF	ON	ON	OFF	OFF	ON	ON	S3	OFF	OFF	OFF	OFF	ON	ON	ON	ON	S4	OFF	OFF	OFF	OFF	OFF	OFF	OFF	OFF	stage	0	1	2	3	4	5	6	7	S1	OFF	ON	OFF	ON	OFF	ON	OFF	ON	S2	OFF	OFF	ON	ON	OFF	OFF	ON	ON	S3	OFF	OFF	OFF	OFF	ON	ON	ON	ON	S4	ON	ON	ON	ON	ON	ON	ON	ON	stage	8	9	10	11	12	13	14	15	0.0%	<input type="radio"/>
S1	OFF	ON	OFF	ON	OFF	ON	OFF	ON																																																																																						
S2	OFF	OFF	ON	ON	OFF	OFF	ON	ON																																																																																						
S3	OFF	OFF	OFF	OFF	ON	ON	ON	ON																																																																																						
S4	OFF	OFF	OFF	OFF	OFF	OFF	OFF	OFF																																																																																						
stage	0	1	2	3	4	5	6	7																																																																																						
S1	OFF	ON	OFF	ON	OFF	ON	OFF	ON																																																																																						
S2	OFF	OFF	ON	ON	OFF	OFF	ON	ON																																																																																						
S3	OFF	OFF	OFF	OFF	ON	ON	ON	ON																																																																																						
S4	ON	ON	ON	ON	ON	ON	ON	ON																																																																																						
stage	8	9	10	11	12	13	14	15																																																																																						
P11 Group Protective parameters																																																																																														
P11.01	Sudden power loss frequency decreasing function selection	0: Enabled 1: Disabled	0	<input type="radio"/>																																																																																										
P11.02	Frequency decreasing ratio of sudden power loss	<p>Setting range: 0.00Hz/s~P00.03 (the Max. frequency)</p> <p>After the power loss of the grid, the bus voltage drops to the sudden frequency-decreasing point, the inverter begin to decrease the running frequency at P11.02, to make the inverter generate power again. The returning power can maintain the bus voltage to ensure a rated running of the inverter until the recovery of power.</p> <table border="1"> <tbody> <tr> <td>Voltage rating</td> <td>230V</td> <td>400V</td> </tr> <tr> <td>Frequency-decreasing point of sudden power loss</td> <td>260V</td> <td>460V</td> </tr> </tbody> </table> <p>Note: 1. Adjust the parameter properly to avoid the stopping caused by inverter protection during the switching of the grid.</p>	Voltage rating	230V	400V	Frequency-decreasing point of sudden power loss	260V	460V	10.00Hz/s	<input type="radio"/>																																																																																				
Voltage rating	230V	400V																																																																																												
Frequency-decreasing point of sudden power loss	260V	460V																																																																																												

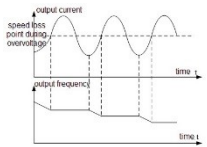
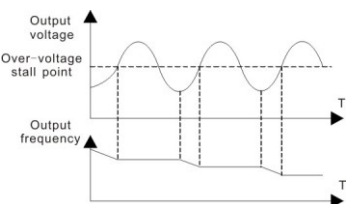
Function code	Name	Detailed instruction of parameters	Default value	Modify
		2. Prohibition of input phase protection can enable this function.		
P11.03	Overvoltage speed loss protection	0:Disabled 1:Enabled 	1	<input type="radio"/>
P11.04	Overvoltage speed loss voltage protection	120~150%(standard bus voltage)(400V)	140%	<input type="radio"/>
		120~150%(standard bus voltage)(230V)	120%	
P11.05	Current limit action selection	During the running of the inverter, this function will detect the output current and compare it with the limit level defined in P11.06. If it exceeds the level, the inverter will	1	<input checked="" type="radio"/>
P11.06	Automatic current limit level	run at stable frequency in ACC running, or the inverter will derate to run during the constant running. If it exceeds the level continuously, the output frequency will keep on decreasing to the lower limit. If the output current is detected to be lower than the limit level, the inverter will accelerate to run.	160.0%	<input checked="" type="radio"/>
P11.07	The decreasing ratio during current limit	 Setting range of P11.05: 0:current limit invalid 1:current limit valid Setting range of P11.06:50.0~200.0% Setting range of P11.07:0.00~50.00Hz/s	10.00Hz/s	<input checked="" type="radio"/>
P11.08	Overload pre-alarm of the motor or the inverter	The output current of the inverter or the motor is above P11.09 and the lasting time is beyond P11.10, overload pre-alarm will be output.	0x000	<input type="radio"/>
P11.09	Overload pre-alarm		150%	<input type="radio"/>

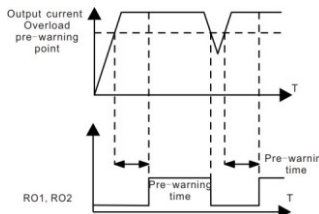
Function code	Name	Detailed instruction of parameters	Default value	Modify
	test level			
P11.10	Overload pre-alarm detection time	<p>Setting range of P11.08: Enable and define the overload pre-alarm of the inverter or the motor. Setting range: 0x000~0x131 LED ones: 0:Overload pre-alarm of the motor, comply with the rated current of the motor 1:Overload pre-alarm of the inverter, comply with the rated current of the inverter LED tens: 0:The inverter continues to work after underload pre-alarm 1:The inverter continues to work after underload pre-alarm and the inverter stops to run after overload fault 2: The inverter continues to work after overload pre-alarm and the inverter stops to run after underload fault 3. The inverter stops when overloading or underloading. LED hundreds : 0:Detection all the time 1:Detection in constant running Setting range of P11.09: P11.11~200% Setting range of P11.10: 0.1~60.0s</p>	1.0s	○
P11.11	Detection level of the underload pre-alarm	<p>If the inverter current or the output current is lower than P11.11, and exceeds time set in P11.12, the inverter will output underload pre-alarm.</p>	50%	○
P11.12	Detection time of the underload pre-alarm	<p>Setting range of P11.11: 0~P11.09 Setting range of P11.12: 0.1~60.0s</p>	1.0s	○

Function code	Name	Detailed instruction of parameters	Default value	Modify
P11.13	Output terminal action selection during fault	Select the action of fault output terminals on undervoltage and fault reset. 0x00~0x11 LED ones: 0:Action under fault undervoltage 1:No action under fault undervoltage LED tens: 0:Action during the automatic reset 1:No action during the automatic reset	0x00	<input type="radio"/>
P14 Group Serial communication				
P14.00	Local communication address	The setting range:1~247 When the master is writing the frame, the communication address of the slave is set to 0; the broadcast address is the communication address. All slaves on the MODBUS fieldbus can receive the frame, but the slave doesn't answer. The communication address of the drive is unique in the communication net. This is the fundamental for the point to point communication between the upper monitor and the drive. Note: The address of the slave cannot be set to 0.	1	<input type="radio"/>
P14.01	Baud rate	Set the digital transmission speed between the upper monitor and the inverter. 0:1200BPS 1:2400BPS 2:4800BPS 3:9600BPS 4:19200BPS 5:38400BPS Note: The baud rate between the upper monitor and the inverter must be the same. The higher the baud rate, the faster the communication speed.	4	<input type="radio"/>
P14.02	Digital bit checkout setting	The data format between the upper monitor and the inverter must be the same. 0: No check (N,8,1) for RTU 1:Odd check (E,8,1) for RTU 2:Even check (O,8,1) for RTU 3:No check (N,8,2) for RTU	1	<input type="radio"/>

Function code	Name	Detailed instruction of parameters	Default value	Modify
		4: Odd check (E,8,2) for RTU 5:Even check(O,8,2) for RTU		
P14.03	Communication response delay	0~200ms It means the interval time between the in time the drive receives the data and sends it to the upper monitor. If the answer delay is shorter than the system processing time, then the answer delay time is the system processing time, if the answer delay is longer than the system processing time, then after the system deal with the data, waits until achieving the answer delay time to send the data to the upper monitor.	5	○
P14.04	Communication overtime fault time	0.0 (invalid),0.1~60.0s When the function code is set as 0.0, the communication overtime parameter is invalid. When the function code is set as non-zero, if the interval time between two communications exceeds the communication overtime, the system will report "485 communication faults" (CE). Generally, set it as invalid; set the parameter in the continuous communication to monitor the communication state.	0.0s	○
P14.05	Transmission fault processing	0:Alarm and stop freely 1:No alarm and continue to run 2:No alarm and stop according to the stop means (only under the communication control) 3:No alarm and stop according to the stop means (under all control modes)	0	○
P14.06	Communication processing action selection	0x00~0x11 LED ones: 0: Operation with response: the drive will respond to all reading and writing commands of the upper monitor. 1: Operation without response; The drive only responds to the reading command other than the writing command of the drive. The communication efficiency can be increased by this method. LED tens:(reserved)	0x00	○

Function code	Name	Detailed instruction of parameters	Default value	Modify
P17 Group Monitoring function				
P17.00	Set frequency	Display current set frequency of the inverter Range: 0.00Hz~P00.03	0.00Hz	●
P17.01	Output frequency	Display current output frequency of the inverter Range: 0.00Hz~P00.03	0.00Hz	●
P17.02	Ramp reference frequency	Display current ramp reference frequency of the inverter Range: 0.00Hz~P00.03	0.00Hz	●
P17.03	Output voltage	Display current output voltage of the inverter Range: 0~1200V	0V	●
P17.04	Output current	Display current output current of the inverter Range: 0.0~5000.0A	0.0A	●
P17.05	The rotation speed of the motor	Display the rotation speed of the motor. Range: 0~65535RPM	0 RPM	●
P17.08	Motor power	Display current power of the motor. Setting range: -300.0%~300.0%(the rated current of the motor)	0.0%	●
P17.09	Output torque	Display the current output torque of the inverter. Range: -250.0~250.0%	0.0%	●
P17.11	DC bus voltage	Display current DC bus voltage of the inverter Range: 0.0~2000.0V	0V	●
P17.12	Switch input terminals state	Display current Switch input terminals state of the inverter Range: 0000~00FF	0	●
P17.13	Switch output terminals state	Display current Switch output terminals state of the inverter Range: 0000~000F	0	●
P17.14	Digital adjustment	Display the adjustment through the keypad of the inverter. Range : 0.00Hz~P00.03	0.00V	●
P17.18	Counting value	Display the current counting number of the inverter. Range: 0~65535	0	●

Function code	Name	Detailed instruction of parameters	Default value	Modify
P17.19	AI1 input voltage	Display analog AI1 input signal Range: 0.00~10.00V	0.00V	●
P17.20	AI2 input voltage	Display analog AI2 input signal Range: 0.00~10.00V	0.00V	●
P17.21	AI3 input voltage	Display analog AI2 input signal Range: -10.00~10.00V	0.00V	●
P17.22	HDI input frequency	Display HDI input frequency Range: 0.00~50.00kHz	0.00 kHz	●
P17.23	PID reference value	Display PID reference value Range: -100.0~100.0%	0.0%	●
P17.24	PID response value	Display PID response value Range: -100.0~100.0%	0.0%	●
P17.25	Power factor of the motor	Display the current power factor of the motor Range: -1.00~1.00		●
P17.26	Current running time	Display the current running time of the inverter. Range:0~65535min	0m	●
P17.27	Current stage of the multi-stage speed	Display simple PLC and the current stage of the multi-stage speed Range: 0~15	0	●
P17.36	Output torque	Display the output torque. Positive value is in the electromotion state, and negative is in the power generating state. Range : -3000.0Nm~3000.0Nm	0	●
P17.37	Counting value of motor overload	0~100 (100: OL1)		●

6 Fault tracking

6.1 Maintenance intervals

If installed in an appropriate environment, the inverter requires very little maintenance. The table lists the routine maintenance intervals recommended by IMO.

Checking part		Checking item	Checking method	Criterion
Ambient environment		Check the ambient temperature, humidity and vibration and ensure there is no dust, gas, oil fog and water.	Visual examination and instrument test	Conforming to the manual
		Ensure there are no tools or other foreign or dangerous objects	Visual examination	There are no tools or dangerous objects.
Voltage		Ensure the main circuit and control circuit are normal.	Measurement by multi-meter	Conforming to the manual
Keypad		Ensure the display is clear and legible	Visual examination	The characters are displayed normally.
		Ensure the characters are displayed correctly	Visual examination	Conforming to the manual
Main circuit	Commonly used	Ensure the screws are tightened securely	Tighten up	NA
		Ensure there is no distortion, cracks, damage or color-changing caused by overheating and aging to the machine and insulator.	Visual examination	NA
		Ensure there is no dust and dirt	Visual examination	Note: Discolouration of copperwork is normal and does not represent a fault.
	The lead of the conductors	Ensure that there is no distortion or color-changing of the conductors caused by overheating.	Visual examination	NA
		Ensure that there are no cracking or color-changing of the protective layers.	Visual examination	NA

Checking part		Checking item	Checking method	Criterion
	Terminals seat	Ensure that there is no damage	Visual examination	NA
	Filter capacitors	Ensure that there is no leakage, color-change, cracking or case expansion.	Visual examination	NA
		Ensure the safety valve is in the right place.	Estimate the usage time according to the maintenance or measure the static capacity.	NA
		If necessary, measure the static capacity.	Measure the capacity by instruments.	The static capacity is above or equal to the original value *0.85.
	Resistors	Ensure there is no damage due to overheating.	Smelling and visual examination	NA
		Ensure resistor is not open circuit.	Visual examination or check with multi-meter	The resistors are in $\pm 10\%$ of the standard value.
	Transformers and reactors	Ensure there is no abnormal vibration, noise or smell.	Listen, smelling and visual examination	NA
	Electromagnetism contactors and relays	Ensure whether there is vibration noise in the workrooms.	Listen.	NA
		Ensure the contactor is correct rating.	Visual examination	NA
	Control circuit	PCB and plugs	Ensure there are no loose screws and contacts.	Tighten loose screws.
Ensure there is no smell and color-changing.			Smelling and visual examination	NA
Ensure there is no cracking, damage distortion or rust.			Visual examination	NA
Ensure there is no leakage or distortion to the capacitors.			Visual examination or estimate the usage time according to the maintenance	NA

Checking part		Checking item	Checking method	Criterion
			information	
Cooling system	Cooling fan	Estimate whether there is abnormal noise and vibration.	Hearing and Visual examination, check fan rotates freely	Stable rotation
		Check the fan is secure in housing	Tighten if loose	NA
		Ensure there is no color-changing caused by overheating.	Visual examination or estimate the usage time according to the maintenance information	NA
	Ventilating duct	Check for debris or foreign object in the cooling fan air vent.	Visual examination	NA

6.1.1 Cooling fan

The inverter's cooling fan has a minimum life span of 25,000 operating hours. The actual life span depends on the inverter usage and ambient temperature.

The operating hours can be found through P07.14 (accumulative hours of the inverter).

Fan failure can be predicted by the increasing noise from the fan bearings. If the inverter is operated in a critical part of a process, fan replacement is recommended once these symptoms appear. Replacement fans are available from IMO.

	⚠ Read and follow the instructions in chapter Safety Precautions. Ignoring the instructions would cause physical injury or death, or damage to the equipment.
---	---

1. Stop the inverter and disconnect it from the AC power source and wait for at least the time designated on the inverter.
2. Lever the fan holder off the drive frame with a screwdriver and lift the hinged fan holder slightly upward from its front edge.
3. Disconnect the fan cable.
4. Remove the fan holder from the hinges.
5. Install the new fan holder including the fan in reverse order.
6. Restore power.

6.1.2 Capacitors

Recharging the capacitors

The DC bus capacitors must be recharged according to the operation instruction if the inverter has been stored for a long time. The storing time is counted from the producing date other than the delivery data which has been marked in the serial number of the inverter.

Time	Operational principle
Storing time less than 1 year	Operation without charging

Time	Operational principle
Storing time 1-2 years	Connect with the power for 1 hour before first ON command
Storing time 2-3 years	Use power surge to charge for the inverter <ul style="list-style-type: none"> • Add 25% rated voltage for 30 minutes • Add 50% rated voltage for 30 minutes • Add 75% rated voltage for 30 minutes • Add 100% rated voltage for 30 minutes
Storing time more than 3 years	Use power surge to charge for the inverter <ul style="list-style-type: none"> • Add 25% rated voltage for 2 hours • Add 50% rated voltage for 2 hours • Add 75% rated voltage for 2 hours • Add 100% rated voltage for 2 hours

The method of using power surge to charge for the inverter:

The right selection of Power surge depends on the supply power of the inverter. Single phase 230V AC/2A power surge applied to the inverter with single/three-phase 230V AC as its input voltage. All DC bus capacitors charge at the same time because there is one rectifier.

High-voltage inverter needs enough voltage (for example, 400V) during charging. The small capacitor power (2A is enough) can be used because the capacitor nearly does not need current when charging.

Change electrolytic capacitors

	◇ Read and follow the instructions in chapter Safety Precautions. Ignoring the instructions may cause physical injury or death, or damage to the equipment.
---	---

Replace electrolytic capacitors after 35000 hours operation. Please contact IMO for assistance.

6.1.3 Power cable

	◇ Read and follow the instructions in chapter Safety Precautions. Ignoring the instructions may cause physical injury or death, or damage to the equipment.
---	---

1. Stop the drive and disconnect it from the power line. Wait for at least the time designated on the inverter.
2. Check the tightness of the power cable connections.
3. Restore power.

6.2 Fault solution

	◇ Only qualified electricians are allowed to maintain the inverter. Read the safety instructions in chapter Safety precautions before working on the inverter.
---	--

6.2.1 Alarm and fault indications

Fault is indicated by LEDs. See **Operation Procedure**. When TRIP light is on, an alarm or fault message on the panel display indicates abnormal inverter state. P07.27~P07.32 records the last 6 faults and P07.33~P07.56 records the operation data of the last 3 faults. Using the information reference in this chapter, most alarms and fault causes can be identified and corrected. For further assistance, contact IMO.

6.2.2 Fault reset

The inverter can be reset by pressing the keypad key **STOP/RST**, through digital input, or by power cycling. When the fault has been cleared, the motor can be restarted.

6.2.3 Fault instruction and solution

Perform the following after inverter fault:

1. Check to ensure keypad functions and displays correctly.
2. If OK, please check P07 and ensure the corresponding recorded fault parameters to confirm the real state when the current fault occurs by all parameters.
3. See the following table for possible cause and remedial action.
4. Remove fault, if error still exists, consult IMO..
5. Check to eliminate the fault and carry out fault reset to run the inverter.

Fault code	Fault type	Possible cause	Remedy action
OC1	Over-current when acceleration	1. The acceleration or deceleration is too fast.	1. Increase the ACC time
OC2	Over-current when deceleration	2. The voltage of the grid is too low.	2. Check the input power
OC3	Over-current when constant speed running	3. The power of the inverter is too low.	3. Select the inverter with a larger power
OV1	Over-voltage during acceleration.	4. The load transients are abnormal.	4. Check if the load is short circuited (the grounding short circuited or the wire short circuited) or the rotation is not smooth.
OV2	Over-voltage during deceleration.	5. Short circuit or phase loss.	5. Check the output configuration.
OV3	Over-voltage at constant speed.	6. There is strong external interference.	6. Check for mechanical resistance.
UV	DC bus Under-voltage	The voltage of the power supply is too low.	1. Check the input power. 2. Extend the accel/decel time. 3. Connect external braking resistor.
OL1	Motor overload	1. The voltage of the power supply is too low. 2. The motor setting rated current is incorrect. 3. The motor stalls or load transients is too strong.	1. Check the power of the supply line 2. Reset the rated current of the motor 3. Check the load and adjust the torque lift
OL3	Electrical overload	The inverter will report overload pre-alarm according to the set value.	Check the load and the overload pre-alarm point.

Fault code	Fault type	Possible cause	Remedy action
OH1	Rectifier overheat	1. Air duct jam or fan damage 2. Ambient temperature is too high. 3. The time of overload running is too long.	1. Refer to the overcurrent solution 2. Ensure fan is clean and not clogged. 3. Low the ambient temperature 4. Check and reconnect 5. Change the power 6. Change the power unit 7. Change the main control panel
OH2	IGBT overheat		
EF	External fault	SI external fault trip operated.	Check the external device input
CE	Communication error	1. The baud rate setting is incorrect. 2. Fault occurs to the communication wiring. 3. The communication address is incorrect. 4. RFI noise.	1. Set correct baud rate. 2. Check the communication connection distribution 3. Set correct communication address. 4. Check earthing connections and cable screening.
EEP	EEPROM fault	1. Error of controlling the write and read of the parameters. 2. Damage to EEPROM	1. Press STOP/RST to reset 2. Change the main control panel.
PIDE	PID feedback fault	1. PID feedback offline. 2. PID feedback signal lost.	1. Check the PID feedback signal. 2. Check the PID feedback source.
END	Time reach of factory setting	The actual running time of the inverter is above the internal setting running time.	Ask for the supplier and adjust the setting running time.
LL	Electronic underload fault	The inverter will report the underload pre-alarm according to the set value.	Check the load and the underload pre-alarm point.

7 Communication protocol

7.1 Brief instruction to Modbus protocol

Modbus protocol is a software protocol and common language which is applied in the electrical controller. With this protocol, the controller can communicate with other devices via network (the channel of signal transmission or the physical layer, such as RS485). And with this industrial standard, the controlling devices of different manufacturers can be connected to an industrial network for the convenient of being monitored.

There are two transmission modes for Modbus protocol: ASCII mode and RTU (Remote Terminal Units) mode. On one Modbus network, all devices should select same transmission mode and their basic parameters, such as baud rate, digital bit, check bit, and stopping bit should have no difference.

Modbus network is a controlling network with single-master and multiple slaves, which means that there is only one device performs as the master and the others are the slaves on one Modbus network. The master means the device which has active talking right to sent message to Modbus network for the controlling and inquiring to other devices. The slave means the passive device which sends data message to the Modbus network only after receiving the controlling or inquiring message (command) form the master (response). After the master sends message, there is a period of time left for the controlled or inquired slaves to response, which ensure there is only one slave sends message to the master at a time for the avoidance of singles impact.

Generally, the user can set PC, PLC, IPC and HMI as the masters to realize central control. Setting certain device as the master is a promise other than setting by a bottom or a switch or the device has a special message format. For example, when the upper monitor is running, if the operator clicks sending command bottom, the upper monitor can send command message actively even it can not receive the message form other devices. In this case, the upper monitor is the master. And if the designer makes the inverter send the data only after receiving the command, then the inverter is the slave.

The master can communicate with any single slave or with all slaves. For the single-visiting command, the slave should feedback a response message; for the broadcasting message from the master, the slave does not need to feedback the response message.

7.2 Application of the inverter

The Modbus protocol of the inverter is RTU mode and the physical layer is 2-wire RS485.

7.2.1 2-wire RS485

The interface of 2-wire RS485 works on semiduplex and its data signal applies differential transmission which is called balance transmission, too. It uses twisted pairs, one of which is defined as A (+) and the other is defined as B (-). Generally, if the positive electrical level between sending drive A and B is among +2~+6V, it is logic“1”, if the electrical level is among -2V~-6V; it is logic“0”.

485+ on the terminal board corresponds to A and 485- to B.

Communication baud rate means the binary bit number in one second. The unit is bit/s (bps). The higher the baud rate is, the quicker the transmission speed is and the weaker the anti-interference is. If the twisted pairs of 0.56mm (24AWG) is applied as the communication cables, the Max. Transmission distance is as below:

Baud rate	Max.transmission distance	Baud rate	Max.transmission distance	Baud rate	Max.transmission distance	Baud rate	Max.transmission distance
2400BPS	1800m	4800BPS	1200m	9600BPS	800m	19200BPS	600m

It is recommended to use shield cables and make the shield layer as the grounding wires during RS485 remote communication.

In the cases with less devices and shorter distance, it is recommended to use 120Ω terminal resistor as the performance will be weakened if the distance increase even though the network can perform well without load resistor.

7.2.1.1 Single application

Figure 1 is the site Modbus connection figure of single inverter and PC. Generally, the computer does not have RS485 interface, the RS232 or USB interface of the computer should be converted into RS485 by converter. Connect the A terminal of RS485 to the 485+ terminal of the inverter and B to the 485- terminal. It is recommended to use the shield twisted pairs. When applying RS232-RS485 converter, if the RS232 interface of the computer is connected to the RS232 interface of the converter, the wire length should be as short as possible within the length of 15m. It is recommended to connect the RS232-RS485 converter to the computer directly. If using USB-RS485 converter, the wire should be as short as possible, too.

Select a right interface to the upper monitor of the computer (select the interface of RS232-RS485 converter, such as COM1) after the wiring and set the basic parameters such as communication baud rate and digital check bit to the same as the inverter.

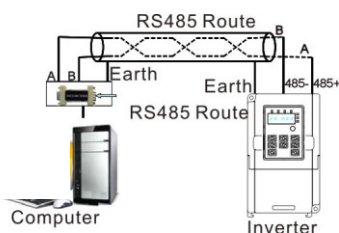

Figure 1 RS485 physical connection in single application

7.2.1.2 Multi-application In the real multi-application, the Daisy-chain connection and star connection are commonly used.

Daisy-chain connection is required in the RS485 industrial fieldbus standards. The two ends are connected to terminal resistors of 120Ω which is shown as figure 2. Figure 3 is the simply connection figure and figure 4 is the real application figure.

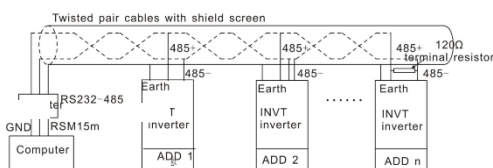

Figure 2 Daisy-chain connection applications

Figure 3 is the star connection. Terminal resistor should be connected to the two devices which have the longest distance. (1# and 15#device)

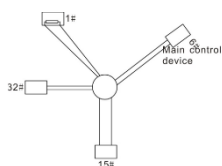

Figure 3 star connection

It is recommended to use shield cables in multiple connection. The basic parameter of the devices, such as baud

rate and digital check bit in RS485 should be the same and there should be no repeated address.

7.2.2 RTU mode

7.2.2.1 RTU communication frame format

If the controller is set to communicate by RTU mode in Modbus network every 8bit byte in the message includes two 4Bit hex characters. Compared with ACSII mode, this mode can send more data at the same baud rate.

Code system

- 1 start bit
- 7 or 8 digital bit, the minimum valid bit can be sent firstly. Every 8 bit frame includes two hex characters (0...9, A...F)
- 1 even/odd check bit . If there is no checkout, the even/odd check bit is inexistent.
- 1 end bit (with checkout), 2 Bit (no checkout).

Error detection field

- CRC

The data format is illustrated as below:

11-bit character frame (BIT1~BIT8 are the digital bits)

Start bit	BIT1	BIT2	BIT3	BIT4	BIT5	BIT6	BIT7	BIT8	Check bit	End bit
-----------	------	------	------	------	------	------	------	------	-----------	---------

10-bit character frame (BIT1~BIT7 are the digital bits)

Start bit	BIT1	BIT2	BIT3	BIT4	BIT5	BIT6	BIT7	Check bit	End bit
-----------	------	------	------	------	------	------	------	-----------	---------

In one character frame, the digital bit takes effect. The start bit, check bit and end bit is used to send the digital bit right to the other device. The digital bit, even/odd checkout and end bit should be set as the same in real application.

The Modbus minimum idle time between frames should be no less than 3.5 bytes. The network device is detecting, even during the interval time, the network bus. When the first field (the address field) is received, the corresponding device decodes next transmitting character. When the interval time is at least 3.5 byte, the message ends.

The whole message frame in RTU mode is a continuous transmitting flow. If there is an interval time (more than 1.5 bytes) before the completion of the frame, the receiving device will renew the uncompleted message and suppose the next byte as the address field of the new message. As such, if the new message follows the previous one within the interval time of 3.5 bytes, the receiving device will deal with it as the same with the previous message. If these two phenomena all happen during the transmission, the CRC will generate a fault message to respond to the sending devices.

The standard structure of RTU frame:

START	T1-T2-T3-T4(transmission time of 3.5 bytes)
ADDR	Communication address: 0~247(decimal system)(0 is the broadcast address)
CMD	03H:read slave parameters 06H:write slave parameters
DATA (N-1) ... DATA (0)	The data of 2*N bytes are the main content of the communication as well as the core of data exchanging
CRC CHK low bit	Detection value:CRC (16BIT)
CRC CHK high bit	

END	T1-T2-T3-T4(transmission time of 3.5 bytes)
-----	---

7.2.2.2 RTU communication frame error checkout

Various factors (such as electromagnetic interference) may cause error in the data transmission. For example, if the sending message is a logic "1", A-B potential difference on RS485 should be 6V, but in reality, it may be -6V because of electromagnetic interference, and then the other devices take the sent message as logic "0". If there is no error checkout, the receiving devices will not find the message is wrong and they may give incorrect response which cause serious result. So the checkout is essential to the message.

The theme of checkout is that: the sender calculate the sending data according to a fixed formula, and then send the result with the message. When the receiver gets this message, they will calculate another result according to the same method and compare it with the sending one. If two results are the same, the message is correct. If not, the message is incorrect.

The error checkout of the frame can be divided into two parts: the bit checkout of the byte and the whole data checkout of the frame (CRC check).

Bit checkout of the byte

The user can select different bit checkouts or non-checkout, which impacts the check bit setting of each byte.

The definition of even checkout: add an even check bit before the data transmission to illustrate the number of "1" in the data transmission is odd number or even number. When it is even, the check byte is "0", otherwise, the check byte is "1". This method is used to stabilize the parity of the data.

The definition of odd checkout: add an odd check bit before the data transmission to illustrate the number of "1" in the data transmission is odd number or even number. When it is odd, the check byte is "0", otherwise, the check byte is "1". This method is used to stabilize the parity of the data.

For example, when transmitting "11001110", there are five "1" in the data. If the even checkout is applied, the even check bit is "1"; if the odd checkout is applied; the odd check bit is "0". The even and odd check bit is calculated on the check bit position of the frame. And the receiving devices also carry out even and odd checkout. If the parity of the receiving data is different from the setting value, there is an error in the communication.

CRC check

The checkout uses RTU frame format. The frame includes the frame error detection field which is based on the CRC calculation method. The CRC field is two bytes, including 16 figure binary values. It is added into the frame after calculated by transmitting device. The receiving device recalculates the CRC of the received frame and compares them with the value in the received CRC field. If the two CRC values are different, there is an error in the communication.

During CRC, 0xFFFF will be stored. And then, deal with the continuous 6-above bytes in the frame and the value in the register. Only the 8Bit data in every character is valid to CRC, while the start bit, the end and the odd and even check bit is invalid.

The calculation of CRC applies the international standard CRC checkout principles. When the user is editing CRC calculation, he can refer to the relative standard CRC calculation to write the required CRC calculation program.

Here provided a simple function of CRC calculation for the reference (programmed with C language):

```
unsigned int crc_cal_value(unsigned char *data_value,unsigned char data_length)
{
int i;
unsigned int crc_value=0xffff;
while(data_length--)
```

```

{  crc_value^=*data_value++;
    for (i=0;i<8;i++)
    {
if (crc_value&0x0001) crc_value=(crc_value>>1)^0xa001;
    else crc_value=crc_value>>1;
    }    }
return (crc_value);
}

```

In ladder logic, CKSM calculated the CRC value according to the frame with the table inquiry. The method is advanced with easy program and quick calculation speed. But the ROM space the program occupied is huge. So use it with caution according to the program required space.

7.3 RTU command code and communication data illustration

7.3.1 Command code: 03H

03H (correspond to binary 0000 0011) ,read N words (Word) (the Max. continuous reading is 16 words)

Command code 03H means that if the master read data form the inverter, the reading number depends on the “data number” in the command code. The Max. Continuous reading number is 16 and the parameter address should be continuous. The byte length of every data is 2 (one word). The following command format is illustrated by hex (a number with “H” means hex) and one hex occupies one byte.

The command code is used to read the working stage of the inverter.

For example, read continuous 2 data content from 0004H from the inverter with the address of 01H (read the content of data address of 0004H and 0005H), the frame structure is as below:

RTU master command message (from the master to the inverter)

START	T1-T2-T3-T4 (transmission time of 3.5 bytes)
ADDR	01H
CMD	03H
High bit of the start bit	00H
Low bit of the start bit	04H
High bit of data number	00H
Low bit of data number	02H
CRC low bit	85H
CRC high bit	CAH
END	T1-T2-T3-T4 (transmission time of 3.5 bytes)

T1-T2-T3-T4 between START and END is to provide at least the time of 3.5 bytes as the leisure time and distinguish two messages for the avoidance of taking two messages as one message.

ADDR = 01H means the command message is sent to the inverter with the address of 01H and ADDR occupies one byte

CMD=03H means the command message is sent to read data form the inverter and CMD occupies one byte

“Start address” means reading data form the address and it occupies 2 bytes with the fact that the high bit is in the front and the low bit is in the behind.

“Data number” means the reading data number with the unit of word. If the “start address’ is 0004H and the “data number” is 0002H, the data of 0004H and 0005H will be read.

CRC occupies 2 bytes with the fact that the high bit is in the front and the low bit is in the behind.

RTU slave response message (from the inverter to the master)

START	T1-T2-T3-T4 (transmission time of 3.5 bytes)
ADDR	01H
CMD	03H
Byte number	04H
Data high bit of address 0004H	13H
Data low bit of address 0004H	88H
Data high bit of address 0005H	00H
Data low bit of address 0005H	00H
CRC CHK low bit	7EH
CRC CHK high bit	9DH
END	T1-T2-T3-T4 (transmission time of 3.5 bytes)

The meaning of the response is:

ADDR = 01H means the command message is sent to the inverter with the address of 01H and ADDR occupies one byte

CMD=03H means the message is received from the inverter to the master for the response of reading command and CMD occupies one byte

“Byte number” means all byte number from the byte (excluding the byte) to CRC byte (excluding the byte). 04 means there are 4 byte of data from the “byte number” to “CRC CHK low bit”, which are “digital address 0004H high bit”, “digital address 0004H low bit”, “digital address 0005H high bit” and “digital address 0005H low bit”.

There are 2 bytes stored in one data with the fact that the high bit is in the front and the low bit is in the behind of the message, the data of data address 0004H is 1388H, and the data of data address 0005H is 0000H.

CRC occupies 2 bytes with the fact that the high bit is in the front and the low bit is in the behind.

7.3.2 Command code: 06H

06H (correspond to binary 0000 0110), write one word (Word)

The command means that the master write data to the inverter and one command can write one data other than multiple dates. The effect is to change the working mode of the inverter.

For example, write 5000 (1388H) to 0004H from the inverter with the address of 02H, the frame structure is as below:

RTU master command message (from the master to the inverter)

START	T1-T2-T3-T4 (transmission time of 3.5 bytes)
ADDR	02H
CMD	06H
High bit of writing data address	00H
Low bit of writing data address	04H
data content	13H
data content	88H
CRC CHK low bit	C5H
CRC CHK high bit	6EH
END	T1-T2-T3-T4 (transmission time of 3.5 bytes)

RTU slave response message (from the inverter to the master)

START	T1-T2-T3-T4 (transmission time of 3.5 bytes)
ADDR	02H
CMD	06H
High bit of writing data address	00H
Low bit of writing data address	04H
High bit of data content	13H
Low bit of data content	88H
CRC CHK low bit	C5H
CRC CHK high bit	6EH
END	T1-T2-T3-T4 (transmission time of 3.5 bytes)

Note: section 10.2 and 10.3 mainly describe the command format, and the detailed application will be mentioned in 10.8 with examples.

7.3.3 Command code 08H for diagnosis

Meaning of sub-function codes

Sub-function Code	Description
0000	Return to inquire information data

For example: The inquiry information string is same as the response information string when the loop detection to address 01H of driver is carried out.

The RTU request command is:

START	T1-T2-T3-T4 (transmission time of 3.5 bytes)
ADDR	01H
CMD	08H
High byte of sub-function code	00H
Low byte of sub-function code	00H
High byte of data content	12H
Low byte of data content	ABH
Low byte of CRC	ADH
High byte of CRC	14H
END	T1-T2-T3-T4 (transmission time of 3.5 bytes)

The RTU response command is:

START	T1-T2-T3-T4 (transmission time of 3.5 bytes)
ADDR	01H
CMD	08H
High byte of sub-function code	00H
Low byte of sub-function code	00H
High byte of data content	12H
Low byte of data content	ABH
Low byte of CRC	ADH
High byte of CRC	14H
END	T1-T2-T3-T4 (transmission time of 3.5 bytes)

7.3.4 The definition of data address

The address definition of the communication data in this part is to control the running of the inverter and get the state information and relative function parameters of the inverter.

7.3.4.1 The rules of parameter address of the function codes

The parameter address occupies 2 bytes with the fact that the high bit is in the front and the low bit is in the behind. The range of high and low byte are: high byte—00~ffH; low byte—00~ffH. The high byte is the group number before the radix point of the function code and the low byte is the number after the radix point. But both the high byte and the low byte should be changed into hex. For example P05.05, the group number before the radix point of the function code is 05, then the high bit of the parameter is 05, the number after the radix point 05, then the low bit of the parameter is 05, then the function code address is 0505H and the parameter address of P10.02 is 0A03H.

P10.02	Multi-stage speed 0	100.0% of the frequency setting corresponds to the Max. Frequency P00.03. When selecting simple PLC running, set P10.02~P10.33 to define the running frequency and direction of all stages.	0.0%	○
P10.04	Multi-stage speed 1	Note: The symbol of multi-stage determines the running direction of simple PLC. The negative value means reverse rotation.	0.0%	○

Note: PE group is the factory parameter which can not be read or changed. Some parameters can not be changed when the inverter is in the running state and some parameters can not be changed in any state. The setting range, unit and relative instructions should be paid attention to when modifying the function code parameters.

Besides, EEPROM is stocked frequently, which may shorten the usage time of EEPROM. For users, some functions are not necessary to be stocked on the communication mode. The needs can be met on by changing the value in RAM. Changing the high bit of the function code form 0 to 1 can also realize the function. For example, the function code P00.07 is not stocked into EEPROM. Only by changing the value in RAM can set the address to 8007H. This address can only be used in writing RAM other than reading. If it is used to read, it is an invalid address.

7.3.4.2 The address instruction of other function in Modbus

The master can operate on the parameters of the inverter as well as control the inverter, such as running or stopping and monitoring the working state of the inverter.

Below is the parameter list of other functions

Function instruction	Address definition	Data meaning instruction	R/W characteristics
Communication control command	2000H	0001H:forward running	W/R
		0002H:reverse running	
		0003H:forward jogging	
		0004H:reverse jogging	
		0005H:stop	
		0006H:coast to stop (emergency stop)	
		0007H:fault reset	
		0008H:jogging stop	
The address of the communication setting value	2001H	Communication setting frequency(0~Fmax(unit: 0.01Hz))	W/R
	2002H	PID reference, range(0~1000, 1000 corresponds to100.0%)	
	2003H	PID feedback, range(0~1000, 1000 corresponds to100.0%)	W/R

Function instruction	Address definition	Data meaning instruction	R/W characteristics
	200AH	Virtual input terminal command , range: 0x000~0x1FF	W/R
	200BH	Virtual input terminal command , range: 0x00~0x0F	W/R
	200DH	AO output setting 1(-1000~1000, 1000 corresponds to 100.0%)	W/R
SW 1 of the inverter	2100H	0001H:forward running 0002H:reverse running 0003H:stop 0004H:fault 0005H: POFF state	R
SW 1 of the inverter	2101H	Bit0: =0:bus voltage is not established =1:bus voltage is established Bit1~2:=00:motor 1 =01:motor 2 =10:motor 3 =11:motor 4 Bit3: =0:asynchronous motor =1:synchronous motor Bit4:=0:pre-alarm without overload =1:overload pre-alarm Bit5~ Bit6:=00:keypad control =01:terminal control =10:communication control	R
Fault code of the inverter	2102H	See the fault type instruction	R
Identifying code of the inverter	2103H	IMO XKL-----0x010d	R
Setting frequency	3001H	Compatible with XKL Series	R
Bus voltage	3002H		R
Output voltage	3003H		R
Output current	3004H		R
Operation speed	3005H		R
Output power	3006H		R
Output torque	3007H		R
PID setting	3008H		R
PID feedback	3009H		R
Input IO state	300AH		R
Output IO state	300BH		R
AI 1	300CH		R
AI 2	300DH		

Function instruction	Address definition	Data meaning instruction	R/W characteristics
Reserved	300EH		
Reserved	300FH		
Reserved	3010H		
Reserved	3011H		
Reserved	3012H		
Reserved	3013H		
External counting value	3014H		
Torque setting	3015H		
Inverter code	3016H		
Fault code	5000H		

R/W characteristics means the function is with read and write characteristics. For example, “communication control command” is writing characteristics and control the inverter with writing command (06H). R characteristic can only read other than write and W characteristic can only write other than read.

Note: when operate on the inverter with the table above, it is necessary to enable some parameters. For example, the operation of running and stopping, it is necessary to set P00.01 to communication running command channel and set P00.02 to MODBUS communication channel. And when operate on “PID reference”, it is necessary to set P09.00 to “MODBUS communication setting”.

The encoding rules for device codes (corresponds to identifying code 2103H of the inverter)

Code high 8bit	Meaning	Code low 8 position	Meaning
01	GD	0x0d	XKL inverters

Note: the code is consisted of 16 bit which is high 8 bits and low 8 bits. High 8 bits mean the motor type series and low 8 bits mean the derived motor types of the series. For example, 0110H means IMO XKL vector inverters.

7.3.5 Fieldbus ratio values

The communication data is expressed by hex in actual application and there is no radix point in hex. For example, 50.12Hz can not be expressed by hex so 50.12 can be magnified by 100 times into 5012, so hex 1394H can be used to express 50.12.

A non-integer can be timed by a multiple to get an integer and the integer can be called fieldbus ratio values.

The fieldbus ratio values are referred to the radix point of the setting range or default value in the function parameter list. If there are figures behind the radix point (n=1), then the fieldbus ratio value m is 10^n . Take the table as the example:

P01.20	Hibernation restore delay time	This function code determines the Hibernation delay time. When the running frequency of the inverter is lower than the lower limit one, the inverter will pause to stand by. When the set frequency is above the lower limit one again and it lasts for the time set by P01.20, the inverter will run automatically. Note: The time is the total value when the set frequency is above the lower limit one.	0.0s	○
--------	--------------------------------	--	------	---

If there is one figure behind the radix point in the setting range or the default value, then the fieldbus ratio value is 10. If the data received by the upper monitor is 50, then the “hibernation restore delay time” is 5.0 (5.0=50÷10).

If Modbus communication is used to control the hibernation restore delay time as 5.0s. Firstly, 5.0 can be magnified by 10 times to integer 50 (32H) and then this data can be sent.



After the inverter receives the command, it will change 50 into 5 according to the fieldbus ratio value and then set the hibernation restore delay time as 5s.

Another example, after the upper monitor sends the command of reading the parameter of hibernation restore delay time ,if the response message of the inverter is as following:



Because the parameter data is 0032H (50) and 50 divided by 10 is 5, then the hibernation restore delay time is 5s.

7.3.6 Fault message response

There may be fault in the communication control. For example, some parameter can only be read. If a writing message is sent, the inverter will return a fault response message.

The fault message is from the inverter to the master, its code and meaning is as below:

Code	Name	Meaning
01H	Illegal command	The command from master can not be executed. The reason maybe: 1. This command is only for new version and this version can not realize. 2. Slave is in fault state and can not execute it.
02H	Illegal data address.	Some of the operation addresses are invalid or not allowed to access. Especially the combination of the register and the transmitting bytes are invalid.
03H	Illegal value	When there are invalid data in the message framed received by slave. Note: This error code does not indicate the data value to write exceed the range, but indicate the message frame is an illegal frame.
04H	Operation failed	The parameter setting in parameter writing is invalid. For example, the function input terminal can not be set repeatedly.
05H	Password error	The password written to the password check address is not same as the password set by P7.00.
06H	Data frame error	In the frame message sent by the upper monitor, the length of the digital frame is incorrect or the counting of CRC check bit in RTU is different from the lower monitor.
07H	Written not allowed.	It only happen in write command, the reason maybe: 1. The written data exceeds the parameter range. 2. The parameter should not be modified now. 3. The terminal has already been used.
08H	The parameter can not be changed during running	The modified parameter in the writing of the upper monitor can not be modified during running.

09H	Password protection	When the upper monitor is writing or reading and the user password is set without password unlocking, it will report that the system is locked.
-----	---------------------	---

The slave uses functional code fields and fault addresses to indicate it is a normal response or some error occurs (named as objection response). For normal responses, the slave shows corresponding function codes, digital address or sub-function codes as the response. For objection responses, the slave returns a code which equals the normal code, but the first byte is logic 1.

For example: when the master sends a message to the slave, requiring it to read a group of address data of the inverter function codes, there will be following function codes:

0 0 0 0 0 1 1 (Hex 03H)

For normal responses, the slave responds the same codes, while for objection responses, it will return:

1 0 0 0 0 1 1 (Hex 83H)

Besides the function codes modification for the objection fault, the slave will respond a byte of abnormal code which defines the error reason.

When the master receives the response for the objection, in a typical processing, it will send the message again or modify the corresponding order.

For example, set the “running command channel” of the inverter (P00.01, parameter address is 0001H) with the address of 01H to 03, the command is as following:

01
Inverter address
06
Write command
00 01
Parameters address
00 03
Parameters data
98 0B
CRC check

But the setting range of “running command channel” is 0~2, if it is set to 3, because the number is beyond the range, the inverter will return fault response message as below:

01
inverter address
86
abnormal response code
04
fault code
43 A3
CRC check

Abnormal response code 86H means the abnormal response to writing command 06H; the fault code is 04H. In the table above, its name is operation failed and its meaning is that the parameter setting in parameter writing is invalid. For example, the function input terminal can not be set repeatedly.

7.3.7 Example of writing and reading

Refer to 10.4.1 and 10.4.2 for the command format.

7.3.7.1 Example of reading command 03H

Read the state word 1 of the inverter with the address of 01H (refer to table 1). From the table 1, the parameter address of the state word 1 of the inverter is 2100H.

The command sent to the inverter:

01
inverter address
03
read parameter
21 00
parameter address
00 01
data number
8E 36
CRC check

If the response message is as below:

01
inverter address
03
read command
02
data number
00 03
data content
F8 45
CRC check

The data content is 0003H. From the table 1, the inverter stops.

Watch “the current fault type” to “the previous 5 times fault type” of the inverter through commands, the corresponding function code is P07.27~P07.32 and corresponding parameter address is 071BH~0720H(there are 6 from 071BH).

The command sent to the inverter:

03 03 07 1B 00 06 B5 59
inverter read start address total 6 parameters CRC check
address command

If the response message is as below:

03 03 0C 00 23 00 23 00 23 00 23 00 23 00 23 5F D2
inverter read byte current fault previous previous 2 previous 3 previous 4 previous 5 CRC check
address command number type fault type fault type fault type fault type fault type

See from the returned data, all fault types are 0023H (decimal 35) with the meaning of maladjustment (STo).

7.3.7.2 Example of writing command 06H

Make the inverter with the address of 03H to run forward. See table 1, the address of “communication control command” is 2000H and forward running is 0001. See the table below.

Function instruction	Address definition	Data meaning instruction	R/W characteristics
Communication control command	2000H	0001H:forward running	W
		0002H:reverse running	
		0003H:forward jogging	
		0004H:reverse jogging	
		0005H:stop	
		0006H:coast to stop (emergency stop)	
		0007H:fault reset	
		0008H:jogging stop	
		0009H:pre-exciting	

The command sent by the master:

03 06 20 00 00 01 42 28
inverter write parameter forward running CRC check
address command address

If the operation is successful, the response may be as below (the same with the command sent by the master):

03 06 20 00 00 01 42 28
inverter write parameter forward running CRC check
address command address

Set the Max. Output frequency of the inverter with the address of 03H as 100Hz.

P00.03	Max. output frequency	This parameter is used to set the maximum output frequency of the inverter. Users should pay attention to this parameter because it is the foundation of the frequency setting and the speed of acceleration and deceleration. Setting range: P00.04~400.00Hz	50.00Hz	⊖
--------	-----------------------	--	---------	---

See the figures behind the radix point, the fieldbus ratio value of the Max. Output frequency (P00.03) is 100. 100Hz timed by 100 is 10000 and the corresponding hex is 2710H.

The command sent by the master:

03 06 00 03 27 10 62 14
inverter write parameter forward running CRC check
address command address

If the operation is successful, the response may be as below (the same with the command sent by the master):

03 06 00 03 27 10 62 14
inverter write parameter forward running CRC check
address command address

Note: the blank in the above command is for illustration. The blank can not be added in the actual application unless the upper monitor can remove the blank by themselves.

Appendix A Technical data

A.1 Ratings

A.1.1 Capacity

Inverter sizing is based on the rated motor current and power. To achieve the rated motor power reference in the table, the rated current of the inverter must be higher than or equal to the rated motor current. Also the rated power of the inverter must be higher than or equal to the rated motor power. The power ratings are the same regardless of the supply voltage within one voltage range.

Note:

1. The maximum allowed motor shaft power is limited to 1.5*PN. If the limit is exceeded, motor torque and current are automatically restricted. The function protects the input bridge of the drive against overload.
2. The ratings apply at ambient temperature of 40 °C
3. It is important to check that in Common DC systems the power flowing through the common DC connection does not exceed PN.

A.1.2 Derating

The load capacity decreases if the installation site ambient temperature exceeds 40 °C, the altitude exceeds 1000 meters or the switching frequency is changed from 4 kHz to 8 kHz.

A.1.2.1 Temperature derating

In the temperature range +40 °C~+50 °C, the rated output current is decreased by 3% for every additional 1 °C. Refer to the below list for the actual derating.

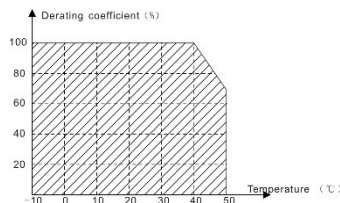

A.1.2.2 Altitude derating

The device can output at rated power if the installation site below 1000m. The output power decreases if the altitude exceeds 1000 meters. Below is the detailed decreasing range of the derating:

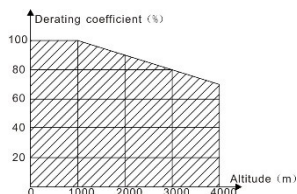

A.1.2.3 De-rating of the carrier frequency

The setting range of carrier frequency in different power rating is different. The rated power is defined as its factory carrier frequency. The inverter has to derate 20% for every additional 1 KHz carrier frequency if the carrier frequency exceeds the factory value.

A.2 CE

A.2.1 CE mark

The CE mark is attached to the drive to verify that the drive follows the provisions of the European Low Voltage (2006/95/EC) and EMC Directives (2004/108/EC).

A.2.2 Compliance with the European EMC Directive

The EMC Directive defines the requirements for immunity and emissions of electrical equipment used within the European Union. The EMC product standard (EN 61800-3:2004) covers requirements stated for drives. See section *EMC regulations*

A.3 EMC regulations

EMC product standard (EN 61800-3:2004) contains the EMC requirements to the inverter.

First environment: domestic environment (includes establishments connected to a low-voltage network which supplies buildings used for domestic purposes).

Second environment includes establishments connected to a network not directly supplying domestic premises.

Four categories of the inverter:

Inverter of category C1: inverter of rated voltage less than 1000 V and used in the first environment.

Inverter of category C2: inverter of rated voltage less than 1000 V other than pins, sockets and motion devices and intended to be installed and commissioned only by a professional electrician when used in the first environment.

Note: IEC/EN 61800-3 in EMC standard doesn't limit the power distribution of the inverter, but it defines the usage, installation and commission. The professional electrician has necessary skills in installing and/or commissioning power drive systems, including their EMC aspects.

Inverter of category C3: inverter of rated voltage less than 1000 V and used in the second environment other than the first one

Inverter of category C4: inverter of rated voltage more than 1000 V or the nominal current is above or equal to 400A and used in the complicated system in second environment

A.3.1 Category C2

The emission limits are complied with the following provisions:

1. The optional EMC filter is selected according to the options and installed as specified in the EMC filter manual.
2. The motor and control cables are selected as specified in this manual.
3. The drive is installed according to the instructions reference in this manual.

	◇ In a domestic environment, this product may cause radio interference, in which case supplementary mitigation measures may be required.
---	--

A.3.2 Category C3

The immunity performance of the drive complies with the demands of IEC/EN 61800-3, second environment.

The emission limits are complied with the following provisions:

1. The optional EMC filter is selected according to the options and installed as specified in the EMC filter manual.
2. The motor and control cables are selected as specified in this manual.
3. The drive is installed according to the instructions reference in this manual.

	◇ A drive of category C3 is not intended to be used on a low-voltage public network which supplies domestic premises. Radio frequency interference is expected if the drive is used on such a network.
---	--

Appendix B Dimension drawings

Dimension drawings of the IMO XKL are shown below. The dimensions are in mm.

B.1 Keypad structure

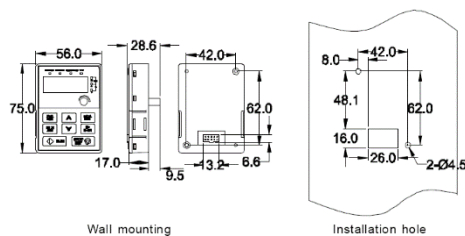

The keypad can be installed on the (optional) installation bracket.

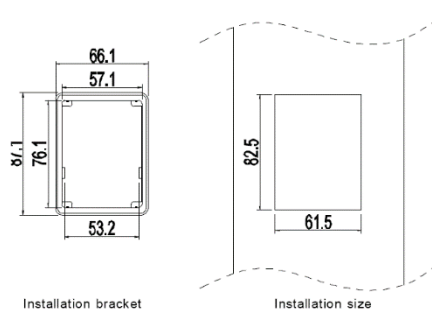

B.2 Inverter dimensions

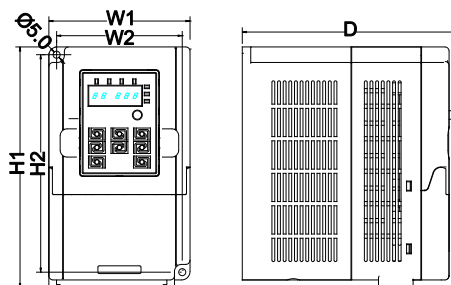

Wall mounting (unit: mm)

Model		W1	W2	H1	H2	D
Single-phase 230V	XKL-040-21	85.0	74.0	145.5	131.5	134.2
	XKL-075-21	85.0	74.0	145.5	131.5	153.2
	XKL-150-21	100.0	89.0	170.5	154.0	153.2
	XKL-220-21	100.0	89.0	170.5	154.0	153.2
Three-phase 400V	XKL-075-43	85.0	74.0	145.5	131.5	153.2
	XKL-150-43	100.0	89.0	170.5	154.0	153.2
	XKL-220-43	100.0	89.0	170.5	154.0	153.2

Appendix C Peripheral options and parts



This chapter describes how to select the options and parts of IMO XKL series inverters.

C.1 Peripheral wiring

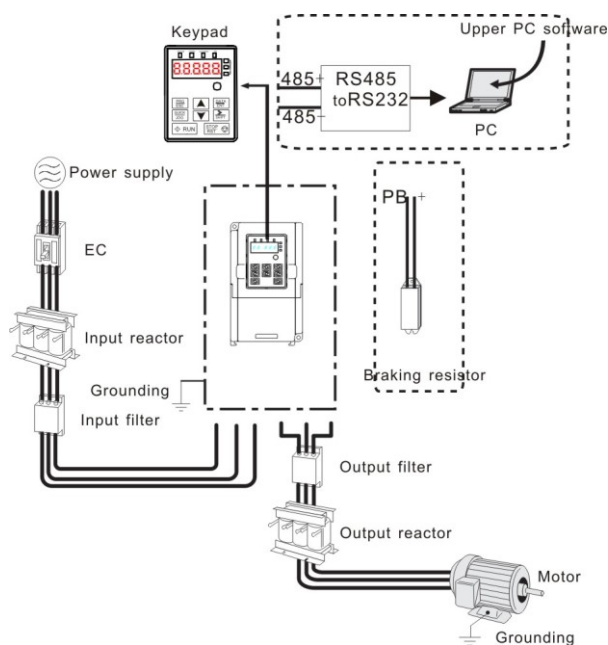
Below is the peripheral wiring of IMO XKL series inverters.



Pictures	Name	Description
	Cables	Device to transfer the electronic signals
	Breaker	Prevent from electric shock and protect the power supply and the cables system from overcurrent when short circuits occur. (Please select the breaker with the function of reducing high order harmonic and the rated sensitive current to 1 inverter should be above 30mA).
	Input reactor	This device is used to improve the power factor of the input side of the inverter and control the higher harmonic current.
	Input filter	Control the electromagnetic interference generated from the inverter, please install close to the input side of the inverter.
	Braking resistors	Shorten the DEC time.
	Output filter	Controls the interference from the output side of the inverter. Install close to the output terminals of the inverter.

Pictures	Name	Description
	Cables	Device to transfer the electronic signals
	Output reactor	Extend the effective transmitting distance of the inverter to control the sudden high voltage when switching on/off the IGBT of the inverter.

C.2 Power supply

	◇ Check that the voltage rating of the inverter complies with the supply voltage.
---	---

C.3 Cables

C.3.1 Power cables

Size the input power and motor cables according to local regulations.

Note: A separate PE conductor is required if the conductivity of the cable shield is not sufficient for the purpose.

C.3.2 Control cables

All analog control cables and the cable used for the frequency input must be shielded.

The relay cable needs the cable type with braided metallic screen.

Note: Run analog and digital signals in separate cables.

Check the insulation of the input power cable according to local regulations before connecting to the drive.

The inverter	Recommended cable size(mm ²)		Connecting cable size(mm ²)				Terminal screw size	Tightening torque (Nm)
	RST UVW	PE	RST UVW	P1 and (+)	PB (+) and (-)	PE		
XKL-040-21	1.5	1.5	1.5	1.5	1.5	1.5	M3	0.56
XKL-075-21	1.5	1.5	1.5	1.5	1.5	1.5	M3	0.56
XKL-150-21	2.5	2.5	2.5	2.5	2.5	2.5	M3	0.8
XKL-220-21	2.5	2.5	2.5	2.5	2.5	2.5	M3	0.8
XKL-075-43	1.5	1.5	1.5	1.5	1.5	1.5	M3	0.8
XKL-150-43	2.5	2.5	2.5	2.5	2.5	2.5	M3	0.8
XKL-220-43	2.5	2.5	2.5	2.5	2.5	2.5	M3	0.8

Note:

1. It is appropriate to use the recommended cable size under 40°C and rated current. The wiring distance should be no more than 100m.
2. Terminals P1, (+), PB and (-) connects the DC reactor options and parts.

C.4 Breaker and electromagnetic contactor

It is necessary to add fuse for the avoidance of overload.

It is appropriate to use a breaker (MCCB) which complies with the inverter power in the 3-phase AC power and input power and terminals. The capacity of the inverter should be 1.5-2 times of the rated current.

	◇ Due to the inherent operating principle and construction of circuit breakers, independent of the manufacturer, hot ionized gases may escape from the breaker enclosure in case of a
---	---

short-circuit. To ensure safe use, special attention must be paid to the installation and placement of the breakers. Follow the manufacturer's instructions.

It is necessary to install the electromagnetic contactor in the input side to control the switching on and off safety of the main circuit. It can switch off the input power supply when system fault.

The inverter	MCCB (A)	Fuse (A)	Contacto (A)
XKL-040-21	16	16	10
XKL-075-21	16	16	16
XKL-150-21	25	25	16
XKL-220-21	50	40	32
XKL-075-43	10	6	10
XKL-150-43	10	10	10
XKL-220-43	16	16	10

C.5 Reactors

High current in the input power circuit may cause damage to the rectifying components. It is appropriate to use AC reactor in the input side for the avoidance of high-voltage input of the power supply and improvement of the power factors.

If the distance between the inverter and the motor is longer than 50m, frequent high current spikes may occur to the inverter because of high leakage current caused by parasitic capacitance effects from the long cables to the ground. In order to avoid the damage of the motor insulation, it is necessary to add reactor compensation.

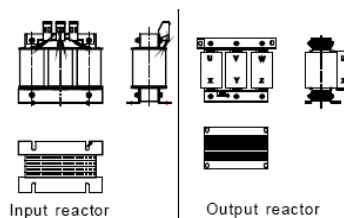

Inverter Model	Input reactor	Output reactor
XKL-040-21	Consult IMO	Consult IMO
XKL-075-21	Consult IMO	Consult IMO
XKL-150-21	Consult IMO	Consult IMO
XKL-220-21	Consult IMO	Consult IMO
XKL-075-43	Consult IMO	Consult IMO
XKL-150-43	Consult IMO	Consult IMO
XKL-220-43	Consult IMO	Consult IMO

Note:

1. The rated derate voltage of the input reactor is $2\% \pm 15\%$.
2. The power factor of the input side is better than 90% when using a DC reactor.
3. The rated derate voltage of the output reactor is $1\% \pm 15\%$.
4. The above options are external, the customer should indicate when purchasing.

C.6 Filters

The input EMC filter can reduce the RFI noise of the inverter to surrounding equipment.

Output filter filter can reduce the RFI noise caused by the cables between the inverter and the motor and the leakage current of the conducting cables.

C3 Filter

The inverter	Input filter	Output filter
XKL-040-21	RFC3-3S	Consult IMO
XKL-075-21	RFC3-3S	Consult IMO
XKL-150-21	RFC3-10S	Consult IMO
XKL-220-21	RFC3-10S	Consult IMO
XKL-075-43	RFC3-6	Consult IMO
XKL-150-43	RFC3-6	Consult IMO
XKL-220-43	RFC3-6	Consult IMO

Note:

1. The Inverter meets category C3 at 3 Mtrs when fitted with above filter.
2. The C3 filters are external mounted option.

C2 Filter

The inverter	Input filter	Output filter
XKL-040-21	RF29A-1A	Consult IMO
XKL-075-21	RF29A-1A	Consult IMO
XKL-150-21	RF29A-1A	Consult IMO
XKL-220-21	RF29A-1A	Consult IMO
XKL-075-43	RF15A-4A	Consult IMO
XKL-150-43	RF15A-4A	Consult IMO
XKL-220-43	RF15A-4A	Consult IMO

Note:

1. The Inverter meets category C2 at 5 Mtrs when fitted with above filter.
2. The C2 filters are external mounted option.

C.7 braking system

C.7.1 Select the braking components

The motor will become a generator if its actual rotating speed is higher than the corresponding speed of the reference frequency. As a result, the inertial energy of the motor and load return to the inverter to charge the capacitors in the main DC circuit. When the voltage increases to the limit, damage may occur to the inverter. It is necessary to apply braking resistor to prevent inverter damage and control stopping of motor.

	<ul style="list-style-type: none"> ✧ Only qualified electricians are allowed to design, install, commission and operate on the inverter. ✧ Follow the instructions in "warning" during working. Physical injury or death or serious damage may occur. ✧ Only qualified electricians are allowed to wire. Damage to the inverter or braking options and part may occur. Read carefully the instructions of braking resistors or units before
---	--



	connecting them with the inverter. ⚡ Do not connect the braking resistor with other terminals except for PB and (-). Damage to the inverter or braking circuit or fire may occur.
	⚡ Connect the braking device with the inverter according to the diagram. Incorrect wiring may cause damage to the inverter or other devices.

Model	Braking resistor at 100% of the braking torque(Ω)	Dissipation power (kW)	Dissipation power (kW)	Dissipation power (kW)	Min braking resistor (Ω)
		10% braking	50% braking	80% braking	
XKL-040-21	361	0.06	0.30	0.48	42
XKL-075-21	192	0.11	0.56	0.90	42
XKL-150-21	96	0.23	1.1	1.8	30
XKL-220-21	65	0.33	1.7	2.6	21
XKL-075-43	653	0.11	0.6	0.9	100
XKL-150-43	326	0.23	1.1	1.8	100
XKL-220-43	222	0.33	1.7	2.6	54

Note:

Select a resistor with wattage and resistance rating as specified in the table above.

The braking resistor may increase the braking torque of the inverter. Above table is measured at 100% braking torque, 10%, 50% and 80% braking usage rate, the user can select braking level according to duty cycle.

	⚡ Do not use brake resistor with a resistance below the minimum value specified for the particular drive. The drive and the internal chopper are not able to handle the overcurrent caused by the low resistance.
	⚡ Increase the power of the braking resistor properly in accordance of the duty cycle (the duty cycle is more than 10%).

C.7.2 Connection of external brake resistor

Install all resistors in a place where they have air clearance.

	⚡ The materials near the brake resistor must be non-flammable. The surface temperature of the resistor can be extremely high, ensure sufficient ventilation for heat dissipation.
---	---

Only external braking resistor is needed in IMO XKL.

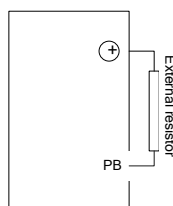

Appendix D Further information

D.1 Product and service inquiries

Address any inquiries about the product to IMO, quoting model type and serial number of the unit in question.

D.2 Document library on the Internet

You can find manuals and other product documents in PDF format on the Internet. Go to www.imopc.com

General Application Inverter.

iDrive2 XKL

Instruction Manual

Second Edition, January 2015

IMO Precision Controls Ltd

The purpose of this instruction manual is to provide accurate information in handling, setting up and operating of the iDrive2 XKL series of inverters. Please feel free to send your comments regarding any errors or omissions you may have found, or any suggestions you may have for generally improving the manual.

In no event will IMO Precision Controls Ltd. be liable for any direct or indirect damages resulting from the application of the information in this manual.

IMO Precision Controls Ltd.

1000 North Circular Road, Staples Corner, London, NW2 7JP England

Phone: +44 (0)20 8452 6444 Fax: +44 (0)20 8450 2274

URL <http://www.imopc.com>
